



MB Medigma
Biomedical
GmbH
PRODUCT CATALOG

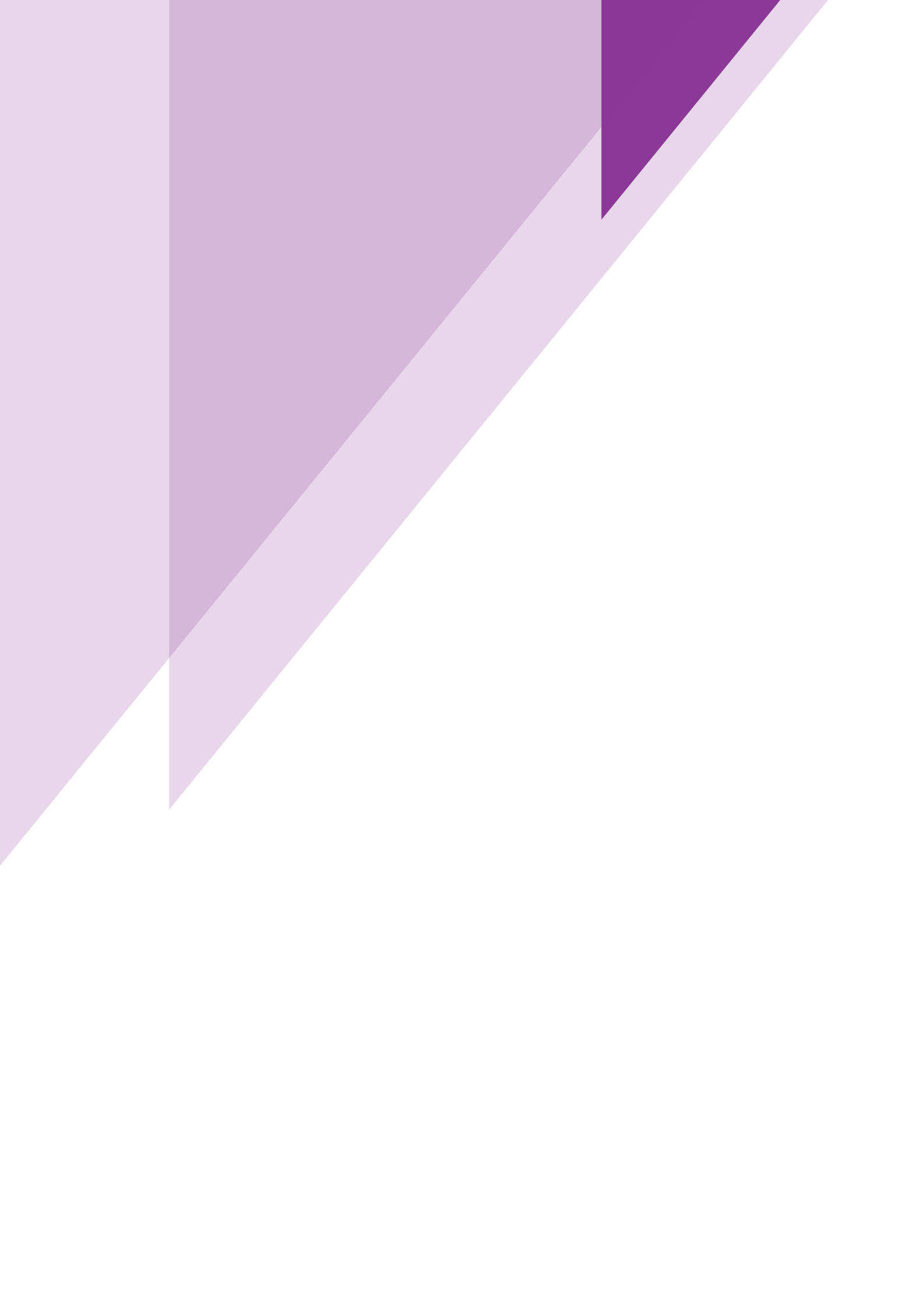

Table of contents

About us	4	Fix-1™	50
Standard Internal Hex Implant Systems	5	∅ 3.0	51
Mars™	6 - 7	∅ 3.3	52
∅ 3.5	8	∅ 3.6	53
∅ 3.75	9	∅ 4.2	54
∅ 4.2	10	∅ 5.0	55
∅ 5.0	11	CAD CAM	56 - 69
∅ 6.0	12	Internal Hex	57
FixTite™-S	13	MU	59
∅ 3.5	14	Fix Konisch™ ND	61 - 62
∅ 3.75	15	Fix Konisch™ SD	63 - 64
∅ 4.2	16	Fix Konisch™ WD	65 - 66
∅ 5.0	17	Accessories	67 - 68
∅ 6.0	18	Analog & Replica	69
Fix-A-Dent™	19	Kit & Tools	70 - 74
∅ 3.3	20	Tools	75 - 77
∅ 3.75	21	Surgical Drills	78
∅ 4.2	22	Drill Stoppers	79
∅ 5.0	23		
∅ 6.0	24		
Fix Konisch™ Conical Hex Connection	29 - 31		
∅ 3.0	32 - 36		
∅ 3.5	37 - 42		
∅ 4.3	43		
∅ 5.0	44 - 49		

About MEDIGMA

Medigma Biomedical GmbH develops, manufactures and distributes dental implant systems, restorative components, surgical and prosthetic tools and accessories. Founded in 1992, Medigma is considered one of the pioneers in the field of Implant Dentistry, and has been providing dentists and dental technicians with innovative solutions.

Medigma's product lines are known for their high precision and user-friendly features. The professional research and development team constantly ensures the production of technologically advanced high-quality products. Medigma works closely with the industry's dental professionals, surgeons, technicians, in both private and public sectors, in order to provide customers with up-to-date industry solutions, knowledge and tools.

Medigma Biomedical GmbH is very proud of its reputation of providing excellent service and quality to customers across the globe, through continuous customer communications, and a variety of dental implant solutions, for restorations ranging from the simplest case to the most complex surgical case.

Medigma's products are CE marked and comply with the highest regulatory requirements.

Medigma aspires to provide an assortment of high-quality products and innovative solutions that meets the needs of our customers with uncompromised service and reasonable prices and to develop, produce and market the highest quality of dental implant products and services.



Standard Internal Hex Implant Systems

► Mars™



AB/AE - Alumina Oxide Blast / Acid Etched Surface Treatment



► FixTite™-S



AB/AE - Alumina Oxide Blast / Acid Etched Surface Treatment



► Fix-a-Dent™



AB/AE - Alumina Oxide Blast / Acid Etched Surface Treatment



► Fix-1™



AB/AE - Alumina Oxide Blast / Acid Etched Surface Treatment



Surface Treatments

AB/AE (SLA™*) -

Alumina Oxide Blasted Large Grit Followed by Acid Etch

AB/AE surface treatment involves blasting with large grit aluminum oxide particles followed by acid etching with sulfuric and hydrochloric acid to remove the embedded particles.

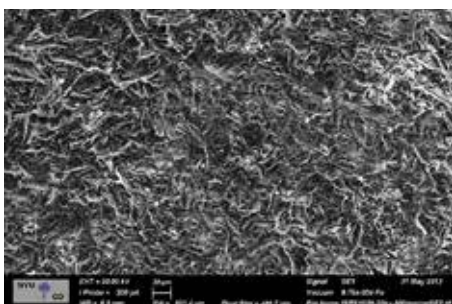

* Institut Straumann AG's trademark



Mars™

Mars™ dental implants are tapered implants with a spiral tap that condenses bone during placement for enhanced immediate stability. The Mars™ implants have two large variable threads and a tapered core for accurate implant placement, self-tapping, improved esthetics and better load distribution.

Mars™ implants feature a special round shaped apex that pushes the bone graft with minimal harm to anatomic structures. Mars™ implants are very user-friendly and their unique design often allows for immediate function for all bone types.

The Mars™ spiral dental implants feature a standard SLA-AB/AE- Alumina Oxide Blasted/Acid Etched surface treatment.

Mars™ features:

- High primary stability, also in type IV bone
- Double lead threads (2x1.2mm)
- Bone-condensing property
- Self-tapping
- Redirecting capability for optimal placement
- Built-in platform switching
- Minimally invasive surgery
- Immediate function / Loading capability
- Single prosthetic platform for easy restoration



AB/AE Surface Treatment

	L-6.25mm	L-8mm	L-10mm	L-11.5mm	L-13mm	L-16mm	L-18mm
Ø3.5mm		113508	113510	113511	113513	113516	113518
Ø3.75mm		113808	113810	113811	113813	113816	113818
Ø4.2mm	114206	114208	114210	114211	114213	114216	114218
Ø5.0mm	115006	115008	115010	115011	115013	115016	
Ø6.0mm	116006	116008	116010	116011	116013		

Mars™ Ø 3.5

- ▶ AB/AE Surface
Titanium Alloy - Ti 6Al 4V ELI

Catalog No.	Length mm
113508	8
113510	10
113511	11.5
113513	13
113516	16
113518	18

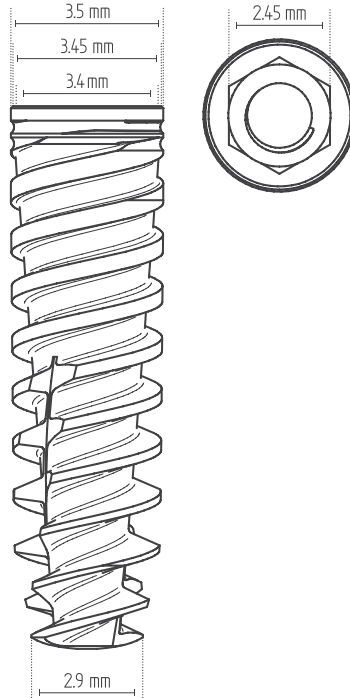
▶ Drill Sequence

BONE TYPE D-IV	BONE TYPE D-II & III	BONE TYPE D-I
1. Tri-Step*	1. Tri-Step* 2. (3.2)	1. Tri-Step* 2. (3.2)

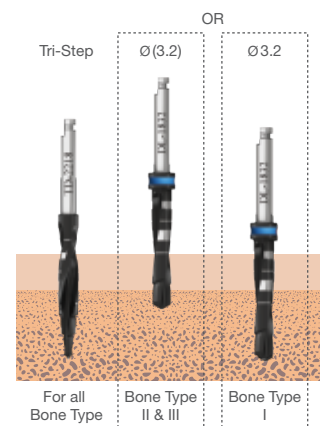

Note: (x.xx) drill to the depth of the cortex only. All measurements are in mm.

⚠ CAUTION: The drill preparation is up to 1mm longer than the implant.

* For initial drilling, you may use 2, 2.8 and 3.2 drills in sequence instead of the Tri-Step drill.

Mars™ Ø 3.75

- ▶ AB/AE Surface
Titanium Alloy - Ti 6Al 4V ELI

Catalog No.	Length mm
113808	8
113810	10
113811	11.5
113813	13
113816	16
113818	18

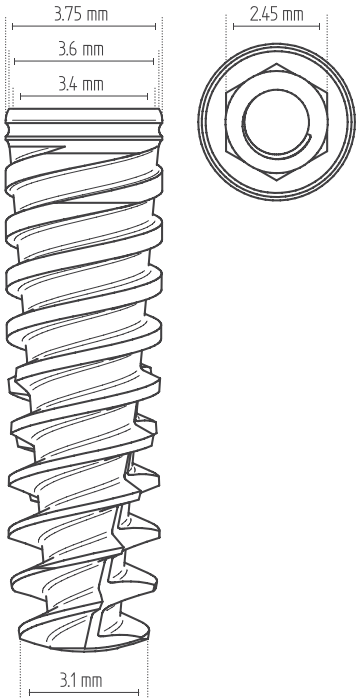
▶ Drill Sequence

BONE TYPE D-IV	BONE TYPE D-II & III	BONE TYPE D-I
1. Tri-Step*	1. Tri-Step* 2. (3.2)	1. Tri-Step* 2. 3.2

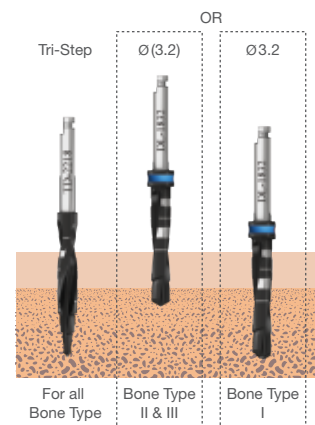

Note: (x.xx) drill to the depth of the cortex only. All measurements are in mm.

⚠ CAUTION: The drill preparation is up to 1mm longer than the implant.

* For initial drilling, you may use 2, 2.8 and 3.2 drills in sequence instead of the Tri-Step drill.

Mars™ Ø 4.2

- ▶ AB/AE Surface
Titanium Alloy - Ti 6Al 4V ELI

Catalog No.	Length mm
114206	6.25
114208	8
114210	10
114211	11.5
114213	13
114216	16
114218	18

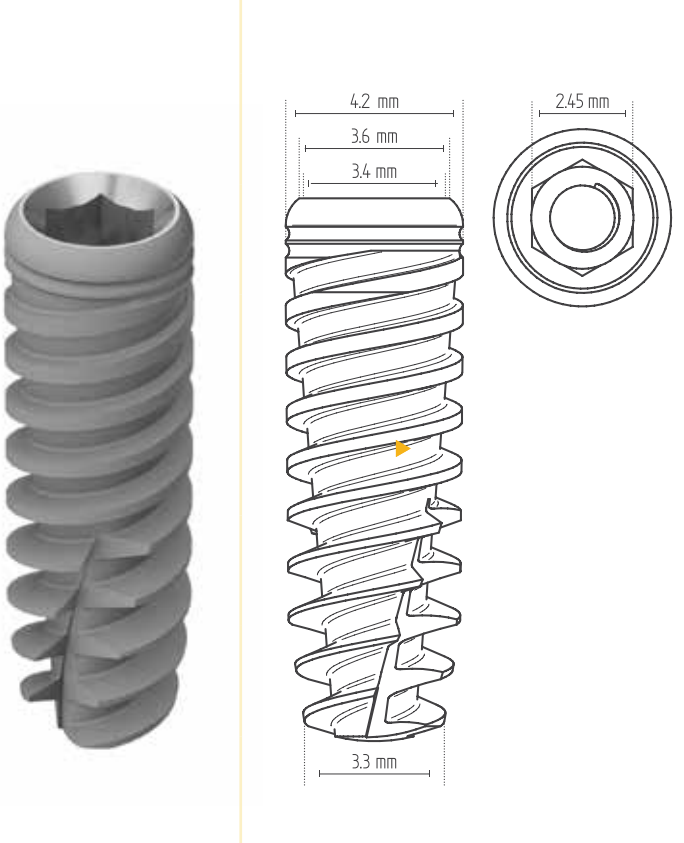

▶ Drill Sequence

BONE TYPE D-IV	BONE TYPE D-II & III	BONE TYPE D-I
1. Tri-Step* 2. (3.6)	1. Tri-Step* 2. (3.6)	1. Tri-Step* 2. 3.6

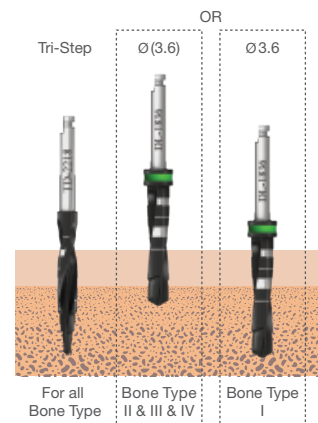

Note: (x.xx) drill to the depth of the cortex only. All measurements are in mm.



CAUTION: The drill preparation is up to 1mm longer than the implant.

* For initial drilling, you may use 2, 2.8 and 3.2 drills in sequence instead of the Tri-Step drill.

Mars™ Ø 5.0

- ▶ AB/AE Surface
Titanium Alloy - Ti 6Al 4V ELI

Catalog No.	Length mm
115006	6.25
115008	8
115010	10
115011	11.5
115013	13
115016	16

- ▶ Drill Sequence

BONE TYPE D-IV	BONE TYPE D-II & III	BONE TYPE D-I
1. Tri-Step*	1. Tri-Step*	1. Tri-Step*
2. 3.6	2. 3.6	2. 3.6
3. (4.2)	3. 4.2	3. 4.2
	4. (4.6)	4. 4.6

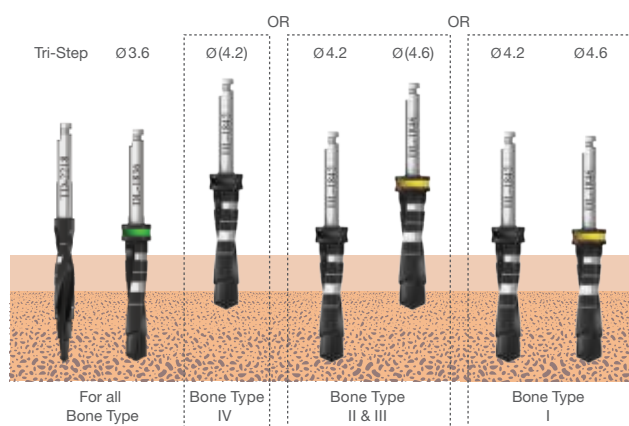

Note: (x.xx) drill to the depth of the cortex only.
All measurements are in mm.

- ⚠ CAUTION: The drill preparation is up to 1mm longer than the implant.
* For initial drilling, you may use 2, 2.8 and 3.2 drills in sequence instead of the Tri-Step drill.

Mars™ Ø 6.0

- ▶ AB/AE Surface
Titanium Alloy - Ti 6Al 4V ELI

Catalog No.	Length mm
116006	6.25
116008	8
116010	10
116011	11.5
116013	13

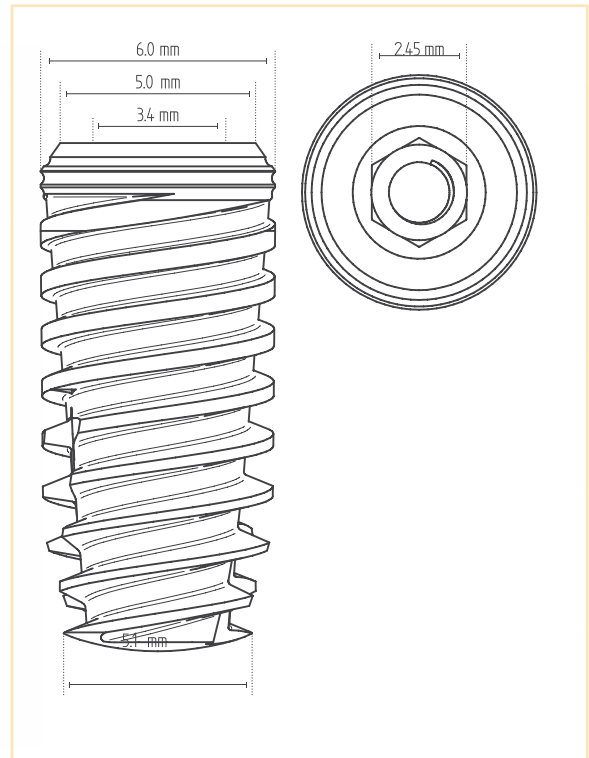

▶ Drill Sequence

BONE TYPE D-IV	BONE TYPE D-II & III	BONE TYPE D-I
1. Tri-Step*	1. Tri-Step*	1. Tri-Step*
2. 3.6	2. 3.6	2. 3.6
3. 4.2	3. 4.2	3. 4.2
4. (5.2)	4. 5.2	4. 5.2
	5. (5.6)	5. 5.6

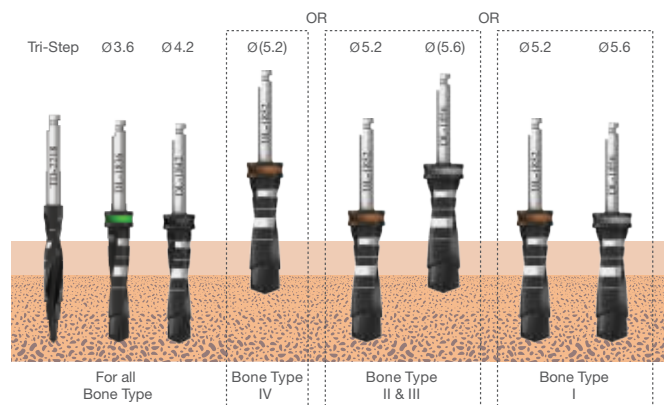

Note: (x.xx) drill to the depth of the cortex only.
All measurements are in mm.

- ⚠ CAUTION: The drill preparation is up to 1mm longer than the implant.
* For initial drilling, you may use 2, 2.8 and 3.2 drills in sequence instead of the Tri-Step drill.

FixTite™-S

FixTite™-S

FixTite™-S is a tapered core dental implant with a unique spiral triple-lead thread and triple vertical flutes design.

FixTite™-S has three major advantages:

Speed

FixTite™-S features a unique triple-lead thread design with 3.6mm (3x1.2mm) pitch. This design allows improved self-drilling, self-cutting and a very fast implant insertion.

Simplicity

A simple surgical procedure and drilling protocol based on three and two step drills sets the stage for accurate implant positioning. Each FixTite™-S implant features a 2.4mm internal hex connection regardless of its diameter. This single prosthetic platform significantly simplifies the restoration.

Stability

FixTite™-S has a conical core, spiral thread and triple vertical flutes design which creates immediate stability, also in type IV bone. The design contributes to balanced load distribution and reduces bone pressure with minimal invasive surgery.

FixTite™-S features a trapezoid thread and AB/AE surface treatment for accelerated osseointegration and increased BIC (Bone to Implant Contact).

FixTite™-S features:

- Triple-lead thread design with 3.6 (3x1.2mm) pitch
- Trapezoid thread, optimal space for a clot of blood
- Single restorative platform, regardless of diameter, with built-in platform switching
- AB/AE surface treatment
- Flat apex designed for improved insertion and placement
- Improved self-drilling and self-cutting
- Three vertical flutes

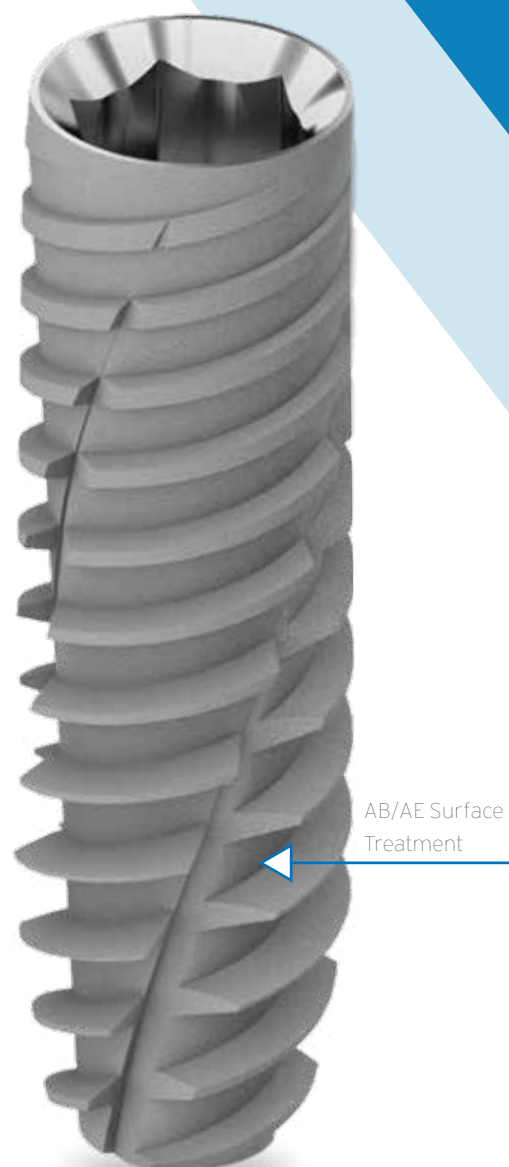

	L-6.25mm	L-8mm	L-10mm	L-11.5mm	L-13mm	L-16mm	L-18mm
Ø3.5mm		35081	35101	35111	35131	35161	35181
Ø3.75mm		37081	37101	37111	37131	37161	37181
Ø4.2mm	42061	42081	42101	42111	42131	42161	42181
Ø5.0mm	50061	50081	50101	50111	50131	50161	
Ø6.0mm	116006	60081	60101	60111	60131	60161	

FixTite™ - S Ø 3.5

- ▶ AB/AE Surface
Titanium Alloy - Ti 6Al 4V ELI

Catalog No.	Length mm
35081	8
35101	10
35111	11.5
35131	13
35161	16
35181	18

▶ Drill Sequence

BONE TYPE D-IV	BONE TYPE D-II & III	BONE TYPE D-I
1. Tri-Step*	1. Tri-Step* 2. (3.2)	1. Tri-Step* 2. (3.2)

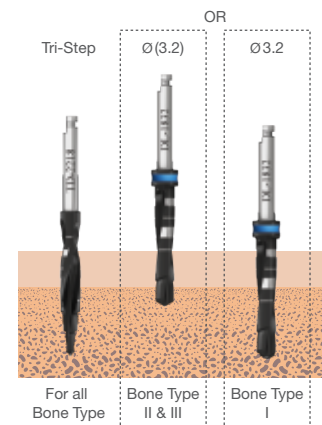

Note: (x.xx) drill to the depth of the cortex only. All measurements are in mm.



CAUTION: The drill preparation is up to 1mm longer than the implant.

* For initial drilling, you may use 2, 2.8 and 3.2 drills in sequence instead of the Tri-Step drill.

FixTite™ - S Ø 3.75

- ▶ AB/AE Surface
Titanium Alloy - Ti 6Al 4V ELI

Catalog No.	Length mm
37081	8
37101	10
37111	11.5
37131	13
37161	16
37181	18

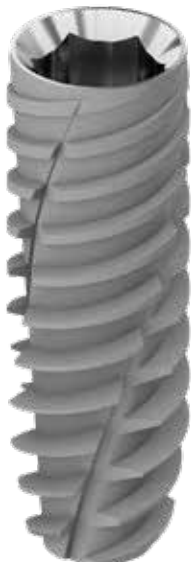
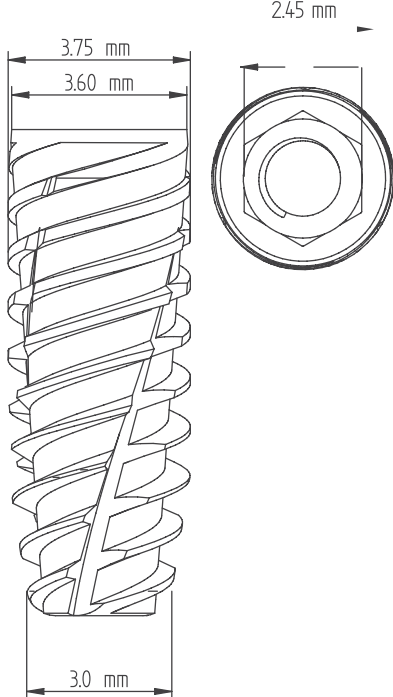
▶ Drill Sequence

BONE TYPE D-IV	BONE TYPE D-II & III	BONE TYPE D-I
1. Tri-Step*	1. Tri-Step* 2. (3.2)	1. Tri-Step* 2. 3.2

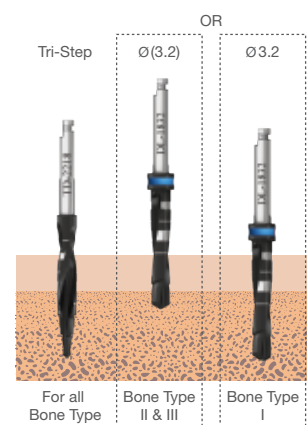

Note: (x.xx) drill to the depth of the cortex only. All measurements are in mm.

⚠ CAUTION: The drill preparation is up to 1mm longer than the implant.

* For initial drilling, you may use 2, 2.8 and 3.2 drills in sequence instead of the Tri-Step drill.

FixTite™ - S Ø 4.2

- ▶ AB/AE Surface
Titanium Alloy - Ti 6Al 4V ELI

Catalog No.	Length mm
42061	6.25
42081	8
42101	10
42111	11.5
42131	13
42161	16
42181	18

▶ Drill Sequence

BONE TYPE D-IV	BONE TYPE D-II & III	BONE TYPE D-I
1. Tri-Step* 2. (3.6)	1. Tri-Step* 2. (3.6)	1. Tri-Step* 2. 3.6

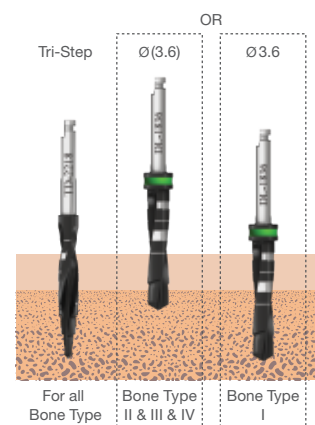

Note: (x.xx) drill to the depth of the cortex only. All measurements are in mm.

⚠ CAUTION: The drill preparation is up to 1mm longer than the implant.

* For initial drilling, you may use 2, 2.8 and 3.2 drills in sequence instead of the Tri-Step drill.

FixTite™ - S Ø 5.0

- ▶ AB/AE Surface
Titanium Alloy - Ti 6Al 4V ELI

Catalog No.	Length mm
50061	6.25
50081	8
50101	10
50111	11.5
50131	13
50161	16

▶ Drill Sequence

BONE TYPE D-IV	BONE TYPE D-II & III	BONE TYPE D-I
1. Tri-Step*	1. Tri-Step*	1. Tri-Step*
2. 3.6	2. 3.6	2. 3.6
3. (4.2)	3. 4.2	3. 4.2
	4. (4.6)	4. 4.6

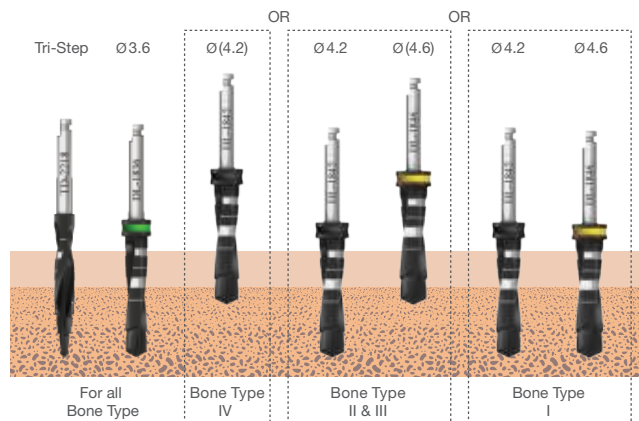

Note: (x.xx) drill to the depth of the cortex only.
All measurements are in mm.

- ⚠ CAUTION: The drill preparation is up to 1mm longer than the implant.
- * For initial drilling, you may use 2, 2.8 and 3.2 drills in sequence instead of the Tri-Step drill.

FixTite™ - S Ø 6.0

- ▶ AB/AE Surface
Titanium Alloy - Ti 6Al 4V ELI

Catalog No.	Length mm
60061	6.25
60081	8
60101	10
60111	11.5
60131	13
60161	16

▶ Drill Sequence

BONE TYPE D-IV	BONE TYPE D-II & III	BONE TYPE D-I
1. Tri-Step*	1. Tri-Step*	1. Tri-Step*
2. 3.6	2. 3.6	2. 3.6
3. 4.2	3. 4.2	3. 4.2
4. (5.2)	4. 5.2	4. 5.2
	5. (5.6)	5. 5.6

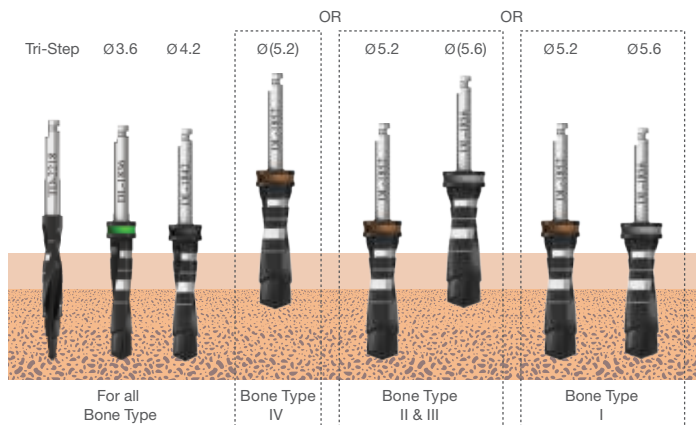

Note: (x.xx) drill to the depth of the cortex only.
All measurements are in mm.



CAUTION: The drill preparation is up to 1mm longer than the implant.

* For initial drilling, you may use 2, 2.8 and 3.2 drills in sequence instead of the Tri-Step drill.

Fix-A-Dent™

Fix-A-Dent™ Straight Implant System

The Fix-A-Dent™ implant is a straight, parallel-walled, slightly tapered implant, with a V-shaped thread design. Its design allows for accurate positioning to improve esthetics and to better load distribution. The Fix-A-Dent™ features AB/AE (Alumina-Oxide Blasted / Acid-Etched) surface treatment.



AB/AE Surface Treatment

	L-6.25mm	L-8mm	L-10mm	L-11.5mm	L-13mm	L-16mm	L-18mm
Ø3.5mm			STA-3310	STA-3311	STA-3313	STA-3316	STA-3318
Ø3.75mm		STA-3708	STA-3710	STA-3711	STA-3713	STA-3716	STA-3718
Ø4.2mm	STA-4206	STA-4208	STA-4210	STA-4211	STA-4213	STA-4216	STA-4218
Ø5.0mm	STA-5006	STA-5008	STA-5010	STA-5011	STA-5013	STA-5016	
Ø6.0mm	STA-6006	STA-6008	STA-6010	STA-6011	STA-6013		

Fix-A-Dent™ - S Ø3.3

- ▶ AB/AE Surface
Titanium Alloy - Ti 6Al 4V ELI

Catalog No.	Length mm
STA-3310	10
STA-3311	11.5
STA-3313	13
STA-3316	16
STA-3318	18

▶ Drill Sequence

BONE TYPE D-IV	BONE TYPE D-II & III	BONE TYPE D-I
1. 2.0 2. (2.8)	1. 2.0 2. (2.8) 3. (3.2)	1. Tri-Step*

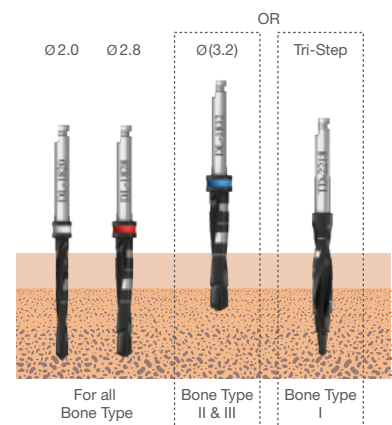

Note: (x.xx) drill to the depth of the cortex only.
All measurements are in mm.

⚠ CAUTION: The drill preparation is up to 1mm longer than the implant.
* For initial drilling, you may use 2, 2.8 and 3.2 drills in sequence instead of the Tri-Step drill.

Fix-A-Dent™ - S Ø3.75

- ▶ AB/AE Surface
Titanium Alloy - Ti 6Al 4V ELI

Catalog No.	Length mm
STA-3708	8
STA-3710	10
STA-3711	11.5
STA-3713	13
STA-3716	16
STA-3718	18

▶ Drill Sequence

BONE TYPE D-IV	BONE TYPE D-II & III	BONE TYPE D-I
1. Tri-Step*	1. Tri-Step* 2. (3.2)	1. Tri-Step* 2. 3.2

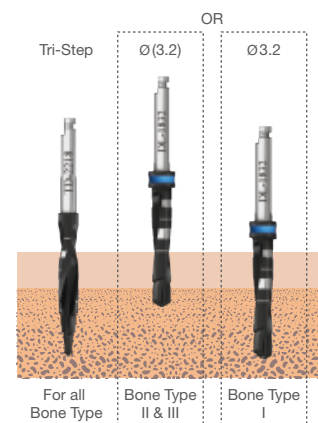

Note: (x.xx) drill to the depth of the cortex only. All measurements are in mm.

⚠ CAUTION: The drill preparation is up to 1mm longer than the implant.

* For initial drilling, you may use 2, 2.8 and 3.2 drills in sequence instead of the Tri-Step drill.

Fix-A-Dent™ - S Ø4.2

- ▶ AB/AE Surface
Titanium Alloy - Ti 6Al 4V ELI

Catalog No.	Length mm
STA-4206	6.25
STA-4208	8
STA-4210	10
STA-4211	11.5
STA-4213	13
STA-4216	16
STA-4218	18

▶ Drill Sequence

BONE TYPE D-IV	BONE TYPE D-II & III	BONE TYPE D-I
1. Tri-Step* 2. 3.2	1. Tri-Step* 2. (3.6)	1. Tri-Step* 2. 3.6

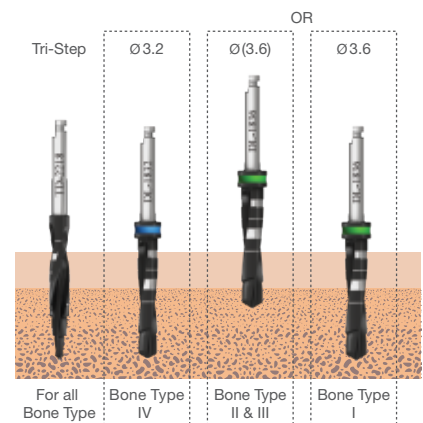

Note: (x.xx) drill to the depth of the cortex only.
All measurements are in mm.

⚠ CAUTION: The drill preparation is up to 1mm longer than the implant.
* For initial drilling, you may use 2, 2.8 and 3.2 drills in sequence instead of the Tri-Step drill.

Fix-A-Dent™ - S Ø5.0

- ▶ AB/AE Surface
Titanium Alloy - Ti 6Al 4V ELI

Catalog No.	Length mm
STA-5006	6.25
STA-5008	8
STA-5010	10
STA-5011	11.5
STA-5013	13
STA-5016	16

▶ Drill Sequence

BONE TYPE D-IV	BONE TYPE D-II & III	BONE TYPE D-I
1. Tri-Step*	1. Tri-Step*	1. Tri-Step*
2. 3.6	2. 3.6	2. 3.6
3. (4.2)	3. 4.2	3. 4.2
	4. (4.6)	4. 4.6

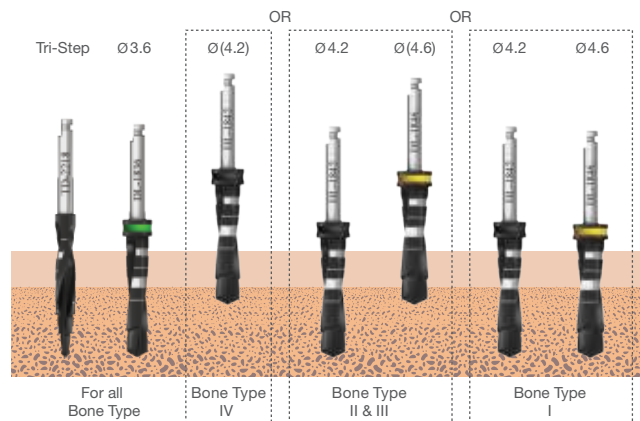

Note: (x.xx) drill to the depth of the cortex only.
All measurements are in mm.

- ⚠ CAUTION: The drill preparation is up to 1mm longer than the implant.
* For initial drilling, you may use 2, 2.8 and 3.2 drills in sequence instead of the Tri-Step drill.

Fix-A-Dent™ - S Ø6.0

- ▶ AB/AE Surface
Titanium Alloy - Ti 6Al 4V ELI

Catalog No.	Length mm
STA-6006	6.25
STA-6008	8
STA-6010	10
STA-6011	11.5
STA-6013	13

▶ Drill Sequence

BONE TYPE D-IV	BONE TYPE D-II & III	BONE TYPE D-I
1. Tri-Step*	1. Tri-Step*	1. Tri-Step*
2. 3.6	2. 3.6	2. 3.6
3. 4.2	3. 4.2	3. 4.2
4. 4.6	4. 4.6	4. 4.6
5. (5.2)	5. 5.2	5. 5.2
	6. (5.6)	6. (5.6)

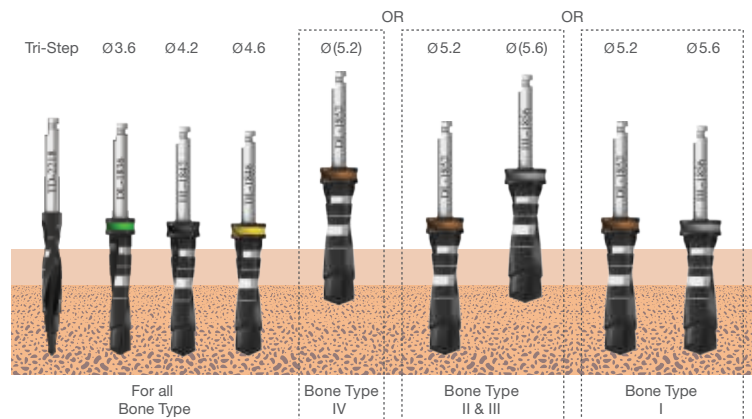















Note: (x.xx) drill to the depth of the cortex only.
All measurements are in mm.

















CAUTION: The drill preparation is up to 1mm longer than the implant.

* For initial drilling, you may use 2, 2.8 and 3.2 drills in sequence instead of the Tri-Step drill.

Healing Abutments & Cover Screw

	CSS	Implant Cover Screw	Ti 6Al 4V ELI
	TGH2-SL	Slim Healing Abutment 3.5mmD x 2mmL	Ti 6Al 4V ELI
	TGH3-SL	Slim Healing Abutment 3.5mmD x 3mmL	Ti 6Al 4V ELI
	TGH4-SL	Slim Healing Abutment 3.5mmD x 4mmL	Ti 6Al 4V ELI
	TGH5-SL	Slim Healing Abutment 3.5mmD x 5mmL	Ti 6Al 4V ELI
	TGH6-SL	Slim Healing Abutment 3.5mmD x 6mmL	Ti 6Al 4V ELI
	TGH2-ST	Healing Abutment 4.5mmD x 2mmL	Ti 6Al 4V ELI
	TGH3-ST	Healing Abutment 4.5mmD x 3mmL	Ti 6Al 4V ELI
	TGH4-ST	Healing Abutment 4.5mmD x 4mmL	Ti 6Al 4V ELI
	TGH5-ST	Healing Abutment 4.5mmD x 5mmL	Ti 6Al 4V ELI
	TGH6-ST	Healing Abutment 4.5mmD x 6mmL	Ti 6Al 4V ELI
	TGH2-WD	Wide Healing Abutment 6mmD x 2mmL	Ti 6Al 4V ELI
	MIH3013	Wide Healing Abutment 6mmD x 3mmL	Ti 6Al 4V ELI
	TGH4-WD	Wide Healing Abutment 6mmD x 4mmL	Ti 6Al 4V ELI
	TGH5-WD	Wide Healing Abutment 6mmD x 5mmL	Ti 6Al 4V ELI







Cement Retained

	SRA3N-3	Slim Titanium Abutment 3mm	Ti 6Al 4V ELI
	SRA3N-6	Slim Titanium Abutment 6mm	Ti 6Al 4V ELI
	SRA3N-8	Slim Titanium Abutment 8mm	Ti 6Al 4V ELI
	SRA3	Straight Titanium Abutment - No End Line	Ti 6Al 4V ELI
	SRA3-1	Straight Titanium Abutment 1mm	Ti 6Al 4V ELI
	SRA3-2	Straight Titanium Abutment 2mm	Ti 6Al 4V ELI
	SRA3-3	Straight Titanium Abutment 3mm	Ti 6Al 4V ELI
	SRA3-4	Straight Titanium Abutment 4mm	Ti 6Al 4V ELI
	SRA3-5	Straight Titanium Abutment 5 mm	Ti 6Al 4V ELI
	TAL11.5	Straight Titanium Abutment Long 12.5mm	Ti 6Al 4V ELI
	SRA5	Straight Titanium Abutment 5mmD	Ti 6Al 4V ELI
	WPSRA	Wide Profile Titanium Abutment	Ti 6Al 4V ELI
	CAS2H	Straight Cylindrical Titanium Abutment 2mm - with Hex	Ti 6Al 4V ELI
	TAS2	Straight Cylindrical Titanium Abutment 2mm - without Hex	Ti 6Al 4V ELI





Cement Retained

	OPA	One Piece Screw-in Abutment	Ti 6Al 4V ELI
	PAB151	Angled Titanium Abutment 15°	Ti 6Al 4V ELI
	PAB151L	Angled Titanium Abutment 15° - Long	Ti 6Al 4V ELI
	PAB251	Angled Titanium Abutment 25°	Ti 6Al 4V ELI
	PAB351	Angled Titanium Abutment 35°	Ti 6Al 4V ELI
	PAB151-1	Esthetic 1mm Angled Titanium Abutment 15°	Ti 6Al 4V ELI
	PAB151-2	Esthetic 2mm Angled Titanium Abutment 15°	Ti 6Al 4V ELI
	PAB151-3	Esthetic 3mm Angled Titanium Abutment 15°	Ti 6Al 4V ELI
	CATPE	Titanium / Plastic Abutment with Hex	Ti 6Al 4V ELI/ POM
	CATPNE	Titanium / Plastic Abutment without Hex	Ti 6Al 4V ELI/ POM
	PRA3N	Plastic Cylinder Casting Abutment	POM
	PRA3N-NH	Plastic Cylinder Casting Abutment w/o Hex	POM
	PRA3	Plastic ST. Abutment Hex	POM
	PRA3-NH	Plastic Standard Abutment w/o Hex	POM
	PRA3R	Plastic Casting ST. Abutment Hex	POM
	PR5040	Plastic Cylinder Abutment Hex	POM

Screw Retained - MU Trans Mucosal Abutments

	TMI1	Straight Trans Mucosal Abutment 1mm	Ti 6Al 4V ELI
	TMI2	Straight Trans Mucosal Abutment 2mm	Ti 6Al 4V ELI
	TMI3	Straight Trans Mucosal Abutment 3mm	Ti 6Al 4V ELI
	TMI4	Straight Trans Mucosal Abutment 4mm	Ti 6Al 4V ELI
	TMI5	Straight Trans Mucosal Abutment 5mm	Ti 6Al 4V ELI
	TMA17	Angled Trans Mucosal Abutment 17° 2mm	Ti 6Al 4V ELI
	TMA1730	Angled Trans Mucosal Abutment 17° 3mm	Ti 6Al 4V ELI
	TMA30	Angled Trans Mucosal Abutment 30° 3mm	Ti 6Al 4V ELI
	TMA3040	Angled Trans Mucosal Abutment 30° 4mm	Ti 6Al 4V ELI
	TMA45	Angled Trans Mucosal Abutment 45° 4mm	Ti 6Al 4V ELI
	TMA-TGH	TMA Healing Cap	Ti 6Al 4V ELI

Screw Retained - MU Trans Muscosal Abutments

	TMA-TTC	TMA Titanium Temporary Cylinder	Ti 6Al 4V ELI
	TMA-PCS	TMA Plastic Casting Sleeve w / Prosthetic Screw	POM
	TMA-A	TMA Abutment Replica	Ti 6Al 4V ELI
	TMA-SRTO	TMA Impression Copying Open Tray	Ti 6Al 4V ELI
	TMA-SRTC	TMA Closed Tray Transfer	Ti 6Al 4V ELI





Ball Attachment - Overdentures

	TMIB1-P3	Ball Attachment 1mm w / Hex	Ti 6Al 4V ELI
	TMIB2-P3	Ball Attachment 2mm w / Hex	Ti 6Al 4V ELI
	TMIB3-P3	Ball Attachment 3mm w / hex	Ti 6Al 4V ELI
	TMIB4-P3	Ball Attachment 4mm w / Hex	Ti 6Al 4V ELI
	TMIB5-P3	Ball Attachment 5mm w / Hex	Ti 6Al 4V ELI
	TMIB6-P3	Ball Attachment 6mm w / Hex	Ti 6Al 4V ELI
	NC01	Plastic Ball Cap - White	Nylon
	NCP	Plastic Ball Cap Pink	Nylon
	HOT	Ball Cap Titanium	Ti 6Al 4V ELI

Analog

	FIA	Internal Hex Implant Analog	Ti 6Al 4V ELI
---	-----	-----------------------------	---------------

Transfer / Impression Coping





	SOT10	Open Tray Slim Transfer 3.6mmDx10mmL	Ti 6Al 4V ELI
	SOT14	Open Tray Slim Transfer 3.6mmDx14mmL	Ti 6Al 4V ELI
	SCT09	Slim Closed Tray Transfer 3.5mmDx9mmL	Ti 6Al 4V ELI
	SCT13	Slim Closed Tray Transfer 3.5mmDx13mmL	Ti 6Al 4V ELI

* Transfers will be chosen by length and width according to the planned prosthetic treatment and according to the interocclusal distance.











IH Retrieval Screw

	SRAS1	Retrieval Screw for Abutments	Ti 6Al 4V ELI
---	-------	-------------------------------	---------------

IH Screws



	CSS	Implant Cover Screw	Ti 6Al 4V ELI
	SRAS	Prosthetic Screw	Ti 6Al 4V ELI
	SRAS2	Short Prosthetic Screw	Ti 6Al 4V ELI
	PAS	Screw for Angled Titanium Abutment	Ti 6Al 4V ELI

IH Screw

	SRAS3	Retaining Screw For Angled TMA	Ti 6Al 4V ELI
	TPS	TMA Prosthetic Screw	Ti 6Al 4V ELI
	TMA-SRAS1	Retaining Screw for TMA 1mm	Ti 6Al 4V ELI
	TMA-SRAS2	Retaining Screw for TMA 2mm	Ti 6Al 4V ELI
	TMA-SRAS3	Retaining Screw for TMA 3mm	Ti 6Al 4V ELI
	TMA-SRAS4	Retaining Screw for TMA 4mm	Ti 6Al 4V ELI
	TMA-SRAS5	Retaining Screw for TMA 5mm	Ti 6Al 4V ELI
	TMA-SRAS-OT	TMA Screw for Open Tray Impression Copying	Ti 6Al 4V ELI
	CTSS	Closed Tray Transfer Screw Short	Ti 6Al 4V ELI
	CTSL	Closed Tray Transfer Screw Long	Ti 6Al 4V ELI

* All systems are provided with their compatible screws. However, they may also be ordered individually.



Prosthetic Hand Drivers

	SHHS	1.27 Hex Hand Driver - Short	Stainless Steel
	SHHM	1.27 Hex Hand Driver - Medium	Stainless Steel
	SHHL	1.27 Hex Hand Driver - Long	Stainless Steel
	TMA-SHHL	TMA/FC Female Hand Hex Driver - Long	Stainless Steel
	TMA-SHHS	TMA/FC Female Hand Hex Driver - Short	Stainless Steel

Torque Drivers

	SMTS	2.4 Hex Torque Driver - Short	Stainless Steel
	SMTL	2.4 Hex Torque Driver - Long	Stainless Steel
	SHT	1.27 Hex Torque Driver - Short	Stainless Steel
	SHTL	1.27 Hex Torque Driver - Long	Stainless Steel
	TDBA	Torque Driver for Ball Attachment	Stainless Steel
	TMA-SHT	TMA/FC Hex Torque Driver - Short	Stainless Steel
	TMA-SHTL	TMA/FC Hex Torque Driver - Long	Stainless Steel

Handpiece Drivers and Adaptors

	TMA-HAS	TMA /FC Hex Handpiece Adapter - Short	Stainless Steel
	TMA-HAL	TMA /FC Hex Handpiece Adapter - Long	Stainless Steel

Fix Konisch™

SD Fix Konisch™

Ø3.5mm
Standard Diameter
for Regular Size
Ridges



ND Fix Konisch™

Ø3.0mm
Narrow Diameter
Ridges and Tight
Spaces

WD Fix Konisch™

Ø4.3/5.0mm
Wide Diameter
for Wide/Large
Ridges

Fix Konisch™ Conical Hex Connection

The Fix Konisch™ spiral implant system offers a unique, strong and solid conical-hex connection. The conical-hex connection enables implants to be used in all indications and regions in the lower and upper jaw. The Morse Taper Connection minimizes micro movements between the implant and abutment.

The Fix Konisch™ spiral implant system is comprised of a tapered core implant with a spiral tap, promoting increased immediate stability. With their unique tip and double lead thread design (2x1.2mm), these implants slice through bone unlike conventional self-tapping implants, which scrape the bone away as they tap.

By repositioning bone as it is being inserted, Fix Konisch™ implants can be placed at different angles for exceptional primary stability and optimal restorative orientation, along with improved esthetics and a better loading distribution.

All Fix Konisch™ implants feature the RBM surface treatment proven to achieve the desired roughness levels needed for optimal osseointegration, increase the rate of Bone to Implant Contact (BIC) and attain the highest implant surface purity levels.

Fix Konisch™ Advantages:

- RBM Surface Treatment
- High Primary Stability, Even in Type IV Bone
- Self-Tapping
- Double Lead Threads (2 X1.2mm)
- Redirecting Capability for more Accurate Implant Placement
- Built-In Platform Switching
- Strong Fix Konisch™ Connection
- Requires Minimally Invasive Surgery
- Immediate Function / Loading Capability in all Bone Types

	L-8mm	L-10mm	L-11.5mm	L-13mm	L-15mm	L-16mm	L-18mm
ND-Ø3.0mm		FKND1030	FKND1130	FKND1330		FKND1630	FKND1830
SD-Ø3.5mm	FKSW0835	FKSW1035	FKSW1135	FKSW1335	FKSW1535		FKSW1835
WD-Ø4.3mm	FKSW0843	FKSW1043	FKSW1143	FKSW1343	FKSW1543		FKSW1843
WD-Ø5.0mm	FKSW0849	FKSW1049	FKSW1149	FKSW1349	FKSW1549		FKSW1849

Fix Konisch™ Implant System

Conical Hex Connection with RBM
Calcium Phosphate Blasted Surface Treatment

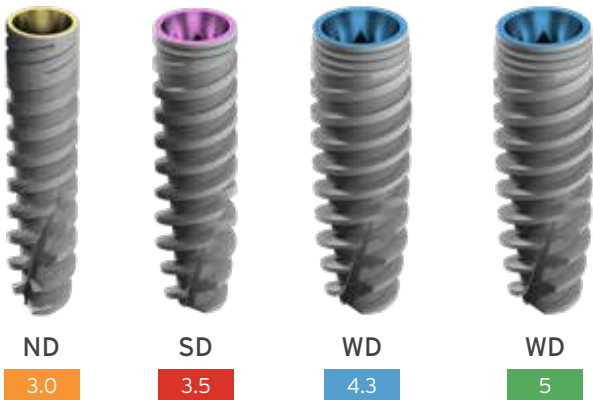

Actual color of implant platforms

Packaging implant diameter color code

RBM

RBM treatment process is achieved by “high-speed particle blasting”, using suitable & resorbable hardened Calcium Phosphate particles. Usage of Calcium Phosphate as the blasting material also eliminates the need of using strong acids for the removal of blasting material remnants.

Following the mechanical abrasion, leftover calcium particles are cleaned off by etching the surface with organic acid of low concentration, leaving no residue and avoiding implant’s titanium surface refurbishment.

RBM Mechanical & Biological Properties:

Successful osteogenesis around the implant, is obtained due to created homogenous pore diameter and uniform surface. Calcium Phosphate is a resorbable, biocompatible substance that does not transfix deeply into the implants surface and does not lodge inside the physically created crater.

In case there are Calcium Phosphate leftover residue on the implant surface, it adds to the osteogenic value of the implant due to the osteoconductive properties it possesses, allowing it to be completely resorbed and replaced by new bone cells. Implant surfaces that have been RBM treated are considered to be more osteoconductive. Research showed higher percentage of bone to implant contact around RBM treated implants. This finding could be especially useful in severe clinical conditions like poor bone quality and in cases of early or immediate loading.

RBM Surface Treatment Advantages:

- Cleaner Implant surface
- Mineralized bone formation contributed by optimal homogenous pore diameter.
- No Titanium nor acid residues left.
- Accelerated Healing & Osseointegration.
- Enlarged implant surface area for optimal contact

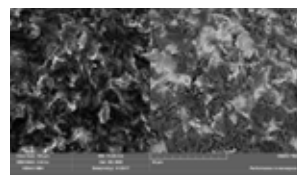

Fix-Konisch™ ND Dental Implant Ø 3.0

- ▶ RBM Surface
Titanium Alloy - Ti 6Al 4V ELI

Catalog No.	Length mm
FKND1030	10
FKND1130	11.5
FKND1330	13
FKND1630	16
FKND1830	18

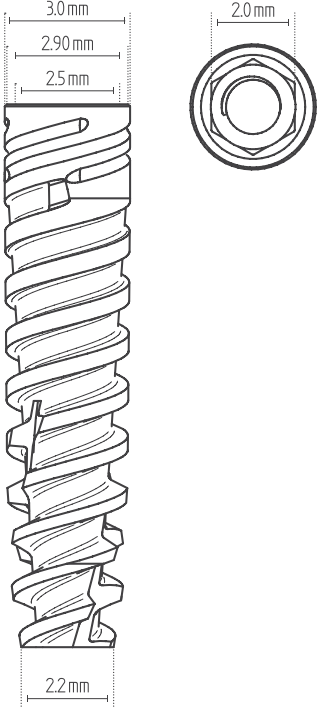
▶ Drill Sequence

BONE TYPE D-IV	BONE TYPE D-II & III	BONE TYPE D-I
1. 2.0	1. 2.0 2. (2.8)	1. 2.0 2. 2.8

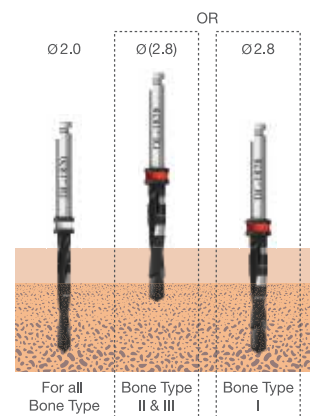

Note: (x.xx) drill to the depth of the cortex only. All measurements are in mm.

⚠ CAUTION: The drill preparation is up to 1mm longer than the implant.



Healing Abutments & Cover Screw

	MND0073	ND Conical Implant Cover Screw	Ti 6Al 4V ELI
	MND0046	ND Slim Healing Abutment 3mmD x 2mmL	Ti 6Al 4V ELI
	MND0047	ND Slim Healing Abutment 3mmD x 3mmL	Ti 6Al 4V ELI
	MND0048	ND Slim Healing Abutment 3mmD x 4mmL	Ti 6Al 4V ELI
	MND0049	ND Slim Healing Abutment 3mmD x 5mmL	Ti 6Al 4V ELI
	MND0050	ND Slim Healing Abutment 3mmD x 6mmL	Ti 6Al 4V ELI
	MND0004	ND Healing Abutment 4.5mmD x 2mmL	Ti 6Al 4V ELI
	MND0008	ND Healing Abutment 4.5mmD x 3mmL	Ti 6Al 4V ELI
	MND0009	ND Healing Abutment 4.5mmD x 4mmL	Ti 6Al 4V ELI
	MND0012	ND Healing Abutment 4.5mmD x 5mmL	Ti 6Al 4V ELI
	MND0013	ND Healing Abutment 4.5mmD x 6mmL	Ti 6Al 4V ELI
	MND0090	ND Conical Healing Abutment 4.5mmD x 2mmL	Ti 6Al 4V ELI
	MND0091	ND Conical Healing Abutment 4.5mmD x 3mmL	Ti 6Al 4V ELI
	MND0092	ND Conical Healing Abutment 4.5mmD x 4mmL	Ti 6Al 4V ELI
	MND0093	ND Conical Healing Abutment 4.5mmD x 5mmL	Ti 6Al 4V ELI
	MND0094	ND Conical Healing Abutment 4.5mmD x 6mmL	Ti 6Al 4V ELI















Cement Retained

	MND0010	ND Straight Slim Abutment - No End Line	Ti 6Al 4V ELI
	MND0019	ND Straight Abutment 1mm	Ti 6Al 4V ELI
	MND0011	ND Straight Abutment 2mm	Ti 6Al 4V ELI
	MND0064	ND Straight Abutment 3mm	Ti 6Al 4V ELI
	MND0018	ND Angled Abutment 15° - No End Line	Ti 6Al 4V ELI
	MND0015	ND Angled Abutment 15° 1mm	Ti 6Al 4V ELI
	MND0026	ND Angled Abutment 15° 2mm	Ti 6Al 4V ELI
	MND0063	ND Angled Abutment 15° 3mm	Ti 6Al 4V ELI
	MND0025	ND Angled Abutment 25° - No End Line	Ti 6Al 4V ELI
	MND0043	ND Anti-rotation Temporary Abutment	Ti 6Al 4V ELI
	MND0043	ND Free Rotation Temporary Abutment	Ti 6Al 4V ELI
	MND0044	ND Plastic Cylinder Abutment	POM

Long Laboratory Screw Flat Connection

	MND3095	ND Anti-rotation Titanium/Plastic Abutment	Ti 6Al 4V ELI / POM
	MND3097	ND Free-rotation Titanium/Plastic Abutment	Ti 6Al 4V ELI / POM

Screw Retained - Multi Unit Abutment (MU)









	MND0032	ND Straight Multi Unit Abutment 1mm	Ti 6Al 4V ELI
	MND0033	ND Straight Multi Unit Abutment 2mm	Ti 6Al 4V ELI
	MND0034	ND Straight Multi Unit Abutment 3mm	Ti 6Al 4V ELI
	MND3729	ND Straight Multi Unit Abutment 4mm	Ti 6Al 4V ELI
	MND3730	ND Straight Multi Unit Abutment 5mm	Ti 6Al 4V ELI
	MND0035	ND Angled Multi Unit Abutment °17 L=3mm	Ti 6Al 4V ELI
	MND0038	ND Angled Multi Unit Abutment °17 L=4mm	Ti 6Al 4V ELI
	MND0036	ND Angled Multi Unit Abutment °30 L=3.5mm	Ti 6Al 4V ELI
	MND0037	ND Angled Multi Unit Abutment °30 L=5mm	Ti 6Al 4V ELI
	TMA-TGH	TMA Healing Cap	Ti 6Al 4V ELI
	TMA-TTC	TMA Titanium Temporary Copying	Ti 6Al 4V ELI
	TMA-PCS	TMA Plastic Casting Sleeve w/Prosthetic Screw	POM
	TMA-A	TMA Abutment Replica	Stainless Steel
	TMA-SRTO	TMA Impression Copying Open Tray	Ti 6Al 4V ELI
	TMA-SRTC	TMA Closed Tray Transfer	Ti 6Al 4V ELI

* The term "impression coping" has been amended to the term "transfer" (the terms are synonymous). Please note that either term may appear in different documentation.

Screw Retained - Flat Connection

	MND0030	ND Flat Connection Abutment 2mm	Ti 6Al 4V ELI
	MND0031	ND Flat Connection Abutment 4mm	Ti 6Al 4V ELI
	FLAT5515	Temporary Cylinder Sleeve Flat Connection	Ti 6Al 4V ELI
	FLAT5737	Implant Replica Flat Connection	Stainless Steel
	FLAT6011	Castable Abutment for Centering Ring Flat Connection	POM
	FLAT6015	Titanium Retaining Screw Flat Connection	Ti 6Al 4V ELI
	FLAT6013	Titanium Gluing Ring Flat Connection	Ti 6Al 4V ELI
	FLAT6017	Long Laboratory Screw Flat Connection	Ti 6Al 4V ELI
	FLAT6018	Centering Ring Flat Connection	Ti 6Al 4V ELI
	FLAT5512	Transfer Flat Connection	Ti 6Al 4V ELI

Bell Attachment - Overdentures

	MND0020	ND Ball Attachment 0.5mm	Ti 6Al 4V ELI
	MND0021	ND Ball Attachment 1mm	Ti 6Al 4V ELI
	MND0022	ND Ball Attachment 2mm	Ti 6Al 4V ELI
	MND0023	ND Ball Attachment 3mm	Ti 6Al 4V ELI
	MND0024	ND Ball Attachment 4mm	Ti 6Al 4V ELI
	NC01	Plastic Ball Cap white	Nylon
	NCP	Plastic Ball Cap Pink Soft	Nylon
	HOT	Ball Cap Titanium	Ti 6Al 4V ELI

Analogs

	MND0007	ND Implant Analog	Ti 6Al 4V ELI
	MIH5740	Ball Attachment Abutment Replica	Stainless Steel

Transfers/Impression Coping

	MND5113	ND Fix Konisch™ Slim Close Tray Transfer 3.2mmDx13mmL	Ti 6Al 4V ELI
	MND5213	ND Fix Konisch™ Close Tray Transfer 4.2mmDx13mmL	Ti 6Al 4V ELI
	MND5614	ND Fix Konisch™ Slim Open Tray Transfer 3.2mmDx14mmL	Ti 6Al 4V ELI
	MND5514	ND Fix Konisch™ Open Tray Transfer 4.2mmDx14mmL	Ti 6Al 4V ELI

ND Screws

	MND0073	ND Conical Implant Cover Screw	Ti 6Al 4V ELI
	MND0001	ND Abutment Screw	Ti 6Al 4V ELI
	MND0039	ND Retaining Screw for MU 1mm	Ti 6Al 4V ELI
	MND0040	ND Retaining Screw for MU 2mm	Stainless Steel
	MND0041	ND Retaining Screw for MU 3mm	POM
	MND3409	ND Retaining Screw for MU 4mm	Ti 6Al 4V ELI
	MND3412	ND Retaining Screw for MU 5mm	Ti 6Al 4V ELI
	MND0042	ND Retaining Screw for Angled MU	Ti 6Al 4V ELI
	MND5014	ND Fix Konisch™ Open Tray Transfer Screw	Ti 6Al 4V ELI
	MND5127	ND Fix Konisch™ Close Tray Transfer Screw	Ti 6Al 4V ELI
	MND0014	ND Retrieval Screw for Abutments	Ti 6Al 4V ELI

* All systems are provided with their compatible screws. However, they may also be ordered individually.

Hand Drivers

	MSD0064	Star Hand Driver-Short	Stainless Steel
	MSD0004	Star Hand Driver - Long	Stainless Steel
	TMA-SHHS	TMA/FC Female Hand Hex Driver - Short	Stainless Steel
	TMA-SHHL	TMA/FC Female Hand Hex Driver - Long	Stainless Steel

Torque Drivers

	MND1001	ND Abutment Insertion Tool	Stainless Steel
	MND0006	ND 2mm Hex Torque Driver - Short	Stainless Steel
	MND0005	ND 2mm Hex Torque Driver - Long	Stainless Steel
	MSD0065	Star Torque Driver-Short	Stainless Steel
	MSD0005	Star Torque Driver - Long	Stainless Steel
	TDBA	Torque Driver for Ball Attachment	Stainless Steel
	TMA-SHT	TMA/FC Hex Torque Driver - Short	Stainless Steel
	TMA-SHTL	TMA/FC Hex Torque Driver - Long	Stainless Steel
	WRS	Wrench Ratchet Surgical Instruments Handle	Stainless Steel

Handpiece Drivers and Adaptors

	MND0068	ND Fix Konisch™ Slim Close Tray Transfer 3.2mmDx13mmL	Ti 6Al 4V ELI
	MND0071	ND Fix Konisch™ Close Tray Transfer 4.2mmDx13mmL	Ti 6Al 4V ELI
	MND0074	ND Fix Konisch™ Slim Open Tray Transfer 3.2mmDx14mmL	Ti 6Al 4V ELI
	MSD0018	ND Fix Konisch™ Open Tray Transfer 4.2mmDx14mmL	Ti 6Al 4V ELI
	MSD0019	ND 2mm Hex Handpiece Adapter - Short	Stainless Steel
	TMA-HAS	ND 2mm Hex Handpiece Adapter - Medium	Stainless Steel
	TMA-HAL	ND 2mm Hex Handpiece Adapter - Long	Stainless Steel

Fix-Konisch™ SD Dental Implant Ø 3.5

- ▶ RBM Surface
Titanium Alloy - Ti 6Al 4V ELI

Catalog No.	Length mm
FKSW0835	8
FKSW1035	10
FKSW1135	11.5
FKSW1335	13
FKSW1535	15
FKSW1835	18

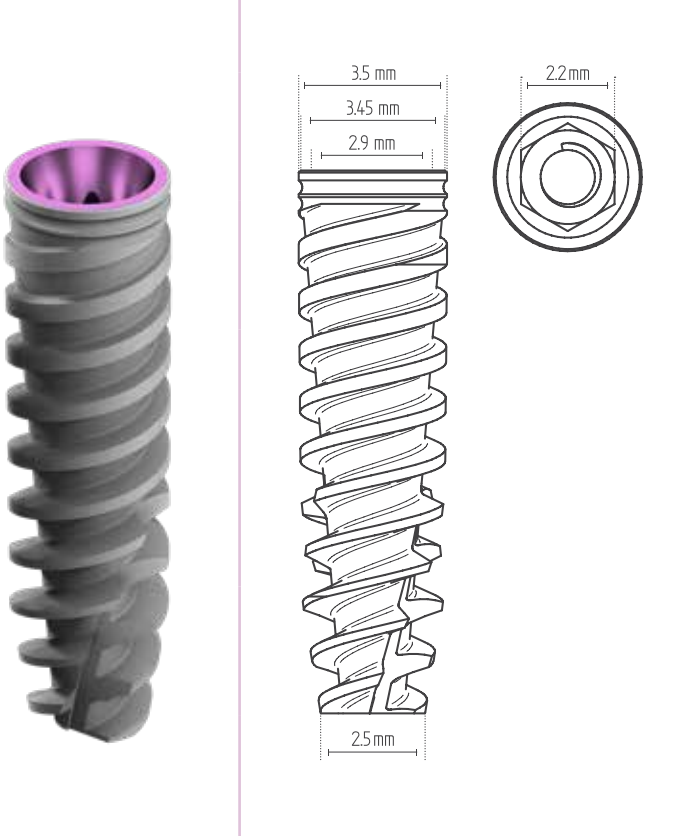

- ▶ Drill Sequence

BONE TYPE D-IV	BONE TYPE D-II & III	BONE TYPE D-I
1. Tri-Step*	1. Tri-Step* 2. (3.2)	1. Tri-Step* 2. (3.2)

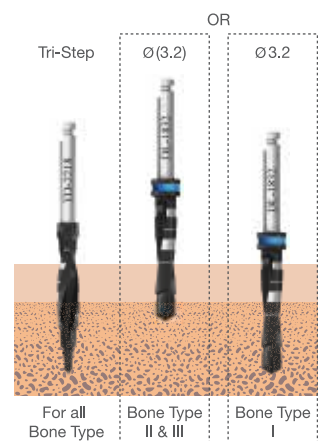

















Note: (x.xx) drill to the depth of the cortex only. All measurements are in mm.







CAUTION: The drill preparation is up to 1mm longer than the implant.

* For initial drilling, you may use 2, 2.8 and 3.2 drills in sequence instead of the Tri-Step drill.















Healing Abutments & Cover Screw

	MSD0073	SD Conical Implant Cover Screw	Ti 6Al 4V ELI
	MSD0046	SD Slim Healing Abutment 3.5mmD x 2mmL	Ti 6Al 4V ELI
	MSD0047	SD Slim Healing Abutment 3.5mmD x 3mmL	Ti 6Al 4V ELI
	MSD0048	SD Slim Healing Abutment 3.5mmD x 4mmL	Ti 6Al 4V ELI
	MSD0049	SD Slim Healing Abutment 3.5mmD x 5mmL	Ti 6Al 4V ELI
	MSD0050	SD Slim Healing Abutment 3.5mmD x 6mmL	Ti 6Al 4V ELI
	MSD0022	SD Healing Abutment 4.5mmD x 2mmL	Ti 6Al 4V ELI
	MSD0023	SD Healing Abutment 4.5mmD x 3mmL	Ti 6Al 4V ELI
	MSD0024	SD Healing Abutment 4.5mmD x 4mmL	Ti 6Al 4V ELI
	MSD0025	SD Healing Abutment 4.5mmD x 5mmL	Ti 6Al 4V ELI
	MSD0026	SD Healing Abutment 4.5mmD x 6mmL	Ti 6Al 4V ELI
	MSD0090	SD Conical Healing Abutment 4.5mmD x 2mmL	Ti 6Al 4V ELI
	MSD0091	SD Conical Healing Abutment 4.5mmD x 3mmL	Ti 6Al 4V ELI
	MSD0092	SD Conical Healing Abutment 4.5mmD x 4mmL	Ti 6Al 4V ELI
	MSD0093	SD Conical Healing Abutment 4.5mmD x 5mmL	Ti 6Al 4V ELI
	MSD0094	SD Conical Healing Abutment 4.5mmD x 6mmL	Ti 6Al 4V ELI

Cement Retained

	MSD0020	SD Straight Slim Abutment - No End Line	Ti 6Al 4V ELI
	MSD0012	SD Straight Abutment 1mm	Ti 6Al 4V ELI
	MSD0011	SD Straight Abutment 2mm	Ti 6Al 4V ELI
	MSD0010	SD Straight Abutment 3mm	Ti 6Al 4V ELI
	MSD0013	SD Angled Abutment 15° - No End Line	Ti 6Al 4V ELI
	MSD0014	SD Angled Abutment 15° 1mm	Ti 6Al 4V ELI
	MSD0015	SD Angled Abutment 15° 2mm	Ti 6Al 4V ELI
	MSD0043	SD Angled Abutment 15° 3mm	Ti 6Al 4V ELI
	MSD0044	SD Angled Abutment 25° - No End Line	Ti 6Al 4V ELI
	MSD0045	SD Anti-rotation Temporary Abutment	POM
	MSD3095	SD Free Rotation Temporary Abutment	Ti 6Al 4V ELI
	MSD3097	SD Plastic Cylinder Abutment	Ti 6Al 4V ELI

Screw Retained - Multi Unit Abutment (MU)









	MSD0032	SD Straight Multi Unit Abutment 1mm	Ti 6Al 4V ELI
	MSD0033	SD Straight Multi Unit Abutment 2mm	Ti 6Al 4V ELI
	MSD0034	SD Straight Multi Unit Abutment 3mm	Ti 6Al 4V ELI
	MSD3729	SD Straight Multi Unit Abutment 4 mm	Ti 6Al 4V ELI
	MSD3730	SD Straight Multi Unit Abutment 5 mm	Ti 6Al 4V ELI
	MSD3734	SD Angled Multi Unit Abutment 2.5 °17mm	Ti 6Al 4V ELI
	MSD3737	SD Angled Multi Unit Abutment 3.5 °17mm	Ti 6Al 4V ELI
	MSD3735	SD Angled Multi Unit Abutment 3 °30mm	Ti 6Al 4V ELI
	MSD3738	SD Angled Multi Unit Abutment 4 °30mm	Ti 6Al 4V ELI
	TMA-TGH	TMA Healing Cap	Ti 6Al 4V ELI
	TMA-TTC	TMA Titanium Temporary Copying	Ti 6Al 4V ELI
	TMA-PCS	TMA Plastic Casting Sleeve w/Prosthetic Screw	POM
	TMA-A	TMA Abutment Replica	Ti 6Al 4V ELI
	TMA-SRTO	TMA Impression Copying Open Tray	Ti 6Al 4V ELI
	TMA-SRTO	MA Closed Tray Transfer	Ti 6Al 4V ELI

* The term "impression coping" has been amended to the term "transfer" (the terms are synonymous). Please note that either term may appear in different documentation.



Screw Retained - Flat Connection

	MSD0030	SD Abutment Flat Connection 2mm	Ti 6Al 4V ELI
	MSD0031	SD Abutment Flat Connection 4mm	Ti 6Al 4V ELI
	FLAT5515	Temporary Cylinder Sleeve Flat Connection	Ti 6Al 4V ELI
	FLAT5737	Implant Replica Flat Connection	Stainless Steel
	FLAT6011	Castable Abutment for Centering Ring Flat Connection	POM
	FLAT6015	Titanium Retaining Screw Flat Connection	Ti 6Al 4V ELI
	FLAT6013	Titanium Gluing Ring Flat Connection	Ti 6Al 4V ELI
	FLAT6017	Long Laboratory Screw Flat Connectio	Ti 6Al 4V ELI
	FLAT6018	Centering Ring Flat Connection	Ti 6Al 4V ELI
	FLAT5512	Transfer Flat Connection	Ti 6Al 4V ELI

Ball Attachment - Overdentures

	MSD0051	SD Ball Attachment 0.5mm	Ti 6Al 4V ELI
	MSD0052	SD Ball Attachment 1mm	Ti 6Al 4V ELI
	MSD0053	SD Ball Attachment 2mm	Ti 6Al 4V ELI
	MSD0054	SD Ball Attachment 3mm	Ti 6Al 4V ELI
	MSD0055	SD Ball Attachment 4mm	Ti 6Al 4V ELI
	MSD0056	SD Ball Attachment 5mm	Ti 6Al 4V ELI
	NC01	Plastic Ball Cap White	Nylon
	NCP	Plastic Ball Cap Pink Soft	Nylon
	HOT	Titanium Ball Cap	Ti 6Al 4V ELI

Analogs

	MSD0007	SD Implant Analog	Ti 6Al 4V ELI
	MIH5740	Ball Attachment Abutment Replica	Stainless Steel

Transfers / Impression Coping

	MSD5109	SD Fix Konisch™ Slim Close Tray Transfer 3.6mmDx9mmL	Ti 6Al 4V ELI
	MSD5113	SD Fix Konisch™ Slim Close Tray Transfer 3.6mmDx13mmL	Ti 6Al 4V ELI
	MSD5209	SD Fix Konisch™ Close Tray Transfer 4.2mmDx9mmL	Ti 6Al 4V ELI
	MSD5213	SD Fix Konisch™ Close Tray Transfer 4.2mmDx13mmL	Ti 6Al 4V ELI
	MSD5610	SD Fix Konisch™ Slim Open Tray Transfer 3.6mmDx10mmL	Ti 6Al 4V ELI
	MSD5614	SD Fix Konisch™ Slim Open Tray Transfer 3.6mmDx14mmL	Ti 6Al 4V ELI
	MSD5510	SD Fix Konisch™ Open Tray Transfer 4.2mmDx10mmL	Ti 6Al 4V ELI
	MSD5514	SD Fix Konisch™ Open Tray Transfer 4.2mmDx14mmL	Ti 6Al 4V ELI













* Transfers can be tightened by Star Driver.

* Transfers will be chosen by length and width according to the planned prosthetic treatment and according to the interocclusal distance.

SD Retrieval Screw





	MSD3401	SD Retrieval Screw for Abutments	Ti 6Al 4V ELI
---	---------	----------------------------------	---------------

SD Screws



	MSD0073	SD Conical Implant Cover Screw	Ti 6Al 4V ELI
	MSD0001	SD Abutment Screw	Ti 6Al 4V ELI
	MSD0039	SD Retaining Screw for MU 1mm	Ti 6Al 4V ELI
	MSD0040	SD Retaining Screw for MU 2mm	Ti 6Al 4V ELI
	MSD0041	SD Retaining Screw for MU 3mm	Ti 6Al 4V ELI
	MSD3409	SD Retaining Screw for MU 4mm	Ti 6Al 4V ELI
	MSD3412	SD Retaining Screw for MU 5mm	Ti 6Al 4V ELI
	MSD3403	SD Retaining Screw for Angled MU	Ti 6Al 4V ELI
	MSD5010	SD Fix Konisch™ Open Tray Transfer Screw Short	Ti 6Al 4V ELI
	MSD5014	SD Fix Konisch™ Open Tray Transfer Screw Long	Ti 6Al 4V ELI
	MSD5126	SD Fix Konisch™ Close Tray Transfer Screw Short	Ti 6Al 4V ELI
	MSD5127	SD Fix Konisch™ Close Tray Transfer Screw Long	Ti 6Al 4V ELI

*All systems are provided with their compatible screws. However, they may also be ordered individually

Hand Drivers

	MSD0064	Star Hand Driver - Short	Stainless Steel
	MSD0004	Star Hand Driver - Long	Stainless Steel
	TMA-SHHS	TMA/FC Female Hand Hex Driver - Short	Stainless Steel
	TMA-SHHL	TMA/FC Female Hand Hex Driver - Long	Stainless Steel

Torque Drivers

	MSD0067	SD 2.2mm Hex Torque Driver-Short	Stainless Steel
	MSD0066	SD 2.2mm Hex Torque Driver-Long	Stainless Steel
	MSD0065	Star Torque Driver - Short	Stainless Steel
	MSD0005	Star Torque Driver - Long	Stainless Steel
	TDBA	Torque Driver for Ball Attachment	Stainless Steel
	TMA-SHT	TMA/FC Hex Torque Driver - Short	Stainless Steel
	TMA-SHTL	TMA/FC Hex Torque Driver - Long	Stainless Steel
	WRS	Wrench Ratchet Surgical Instruments Handle * use with MSD0068/ MSD0071/ MSD0074	Stainless Steel

Handpiece Drivers and Adaptors

	MSD0068	SD Fix Konisch™ Close Tray Transfer 4.2mmDx13mmL	Stainless Steel
	MSD0071	SD Fix Konisch™ Slim Open Tray Transfer 3.6mmDx10mmL	Stainless Steel
	MSD0074	SD Fix Konisch™ Slim Open Tray Transfer 3.6mmDx14mmL	Stainless Steel
	MSD0018	SD Fix Konisch™ Open Tray Transfer 4.2mmDx10mmL	Stainless Steel
	MSD0019	SD Fix Konisch™ Open Tray Transfer 4.2mmDx14mmL	Stainless Steel
	TMA-HAS	TMA/FC Hex Hand Piece Adapter - Short	Stainless Steel
	TMA-HAL	TMA/FC Hex Hand Piece Adapter - Long	Stainless Steel

Fix-Konisch™ WD Dental Implant Ø 4.3

- ▶ RBM Surface
Titanium Alloy - Ti 6Al 4V ELI

Catalog No.	Length mm
FKSW0843	8
FKSW1043	10
FKSW1143	11.5
FKSW1343	13
FKSW1543	15
FKSW1843	18

- ▶ Drill Sequence

BONE TYPE D-IV	BONE TYPE D-II & III	BONE TYPE D-I
1. Tri-Step* 2. (3.6)	1. Tri-Step* 2. (3.6)	1. Tri-Step* 2. 3.6

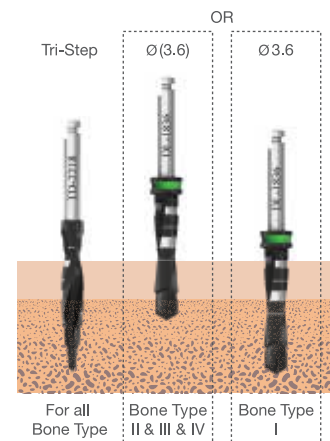

Note: (x.xx) drill to the depth of the cortex only. All measurements are in mm.



CAUTION: The drill preparation is up to 1mm longer than the implant.

* For initial drilling, you may use 2, 2.8 and 3.2 drills in sequence instead of the Tri-Step drill.

Fix-Konisch™ WD Dental Implant Ø 5.0

- ▶ RBM Surface
Titanium Alloy - Ti 6Al 4V ELI

Catalog No.	Length mm
FKSW0849	8
FKSW1049	10
FKSW1149	11.5
FKSW1349	13
FKSW1549	15
FKSW1849	18

▶ Drill Sequence



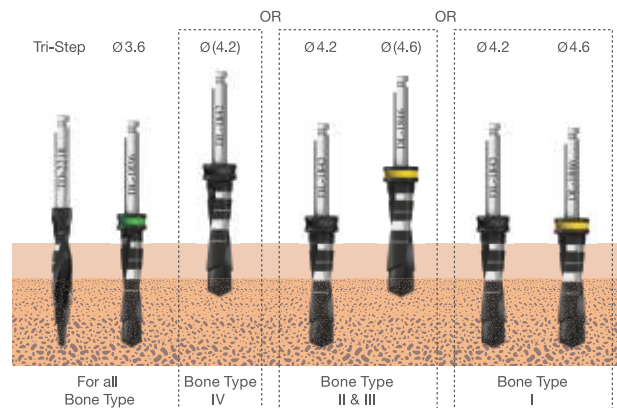

BONE TYPE D-IV	BONE TYPE D-II & III	BONE TYPE D-I
1. Tri-Step*	1. Tri-Step*	1. Tri-Step*
2. 3.6	2. 3.6	2. 3.6
3. (4.2)	3. 4.2	3. 4.2
	4. (4.6)	4. 4.6









Note: (x.xx) drill to the depth of the cortex only.
All measurements are in mm.

- ⚠ CAUTION: The drill preparation is up to 1mm longer than the implant.
* For initial drilling, you may use 2, 2.8 and 3.2 drills in sequence instead of the Tri-Step drill.















Healing Abutments & Cover Screw

	MWD0073	WD Conical Implant Cover Screw	Ti 6Al 4V ELI
	MWD0046	WD Slim Healing Abutment 4mmD x 2mmL	Ti 6Al 4V ELI
	MWD0047	WD Slim Healing Abutment 4mmD x 3mmL	Ti 6Al 4V ELI
	MWD0048	WD Slim Healing Abutment 4mmD x 4mmL	Ti 6Al 4V ELI
	MWD0049	WD Slim Healing Abutment 4mmD x 5mmL	Ti 6Al 4V ELI
	MWD0050	WD Slim Healing Abutment 4mmD x 6mmL	Ti 6Al 4V ELI
	MWD0022	WD Healing Abutment 5.5mmD x 2mmL	Ti 6Al 4V ELI
	MWD0023	WD Healing Abutment 5.5mmD x 3mmL	Ti 6Al 4V ELI
	MWD0024	WD Healing Abutment 5.5mmD x 4mmL	Ti 6Al 4V ELI
	MWD0025	WD Healing Abutment 5.5mmD x 5mmL	Ti 6Al 4V ELI
	MWD0026	WD Healing Abutment 5.5mmD x 6mmL	Ti 6Al 4V ELI
	MWD0090	WD Conical Healing Abutment 5.5mmD x 2mmL	Ti 6Al 4V ELI
	MWD0091	WD Conical Healing Abutment 5.5mmD x 3mmL	Ti 6Al 4V ELI
	MWD0092	WD Conical Healing Abutment 5.5mmD x 4mmL	Ti 6Al 4V ELI
	MWD0093	WD Conical Healing Abutment 5.5mmD x 5mmL	Ti 6Al 4V ELI
	MWD0094	WD Conical Healing Abutment 5.5mmD x 6mmL	Ti 6Al 4V ELI

Cement Retained

	MWD0020	WD Straight Slim Abutment-No End Line	Ti 6Al 4V ELI
	MWD0012	WD Straight Abutment 1mm	Ti 6Al 4V ELI
	MWD0011	WD Straight Abutment 2mm	Ti 6Al 4V ELI
	MWD0010	WD Straight Abutment 3mm	Ti 6Al 4V ELI
	MWD0013	WD Angled Abutment 1 °15mm	Ti 6Al 4V ELI
	MWD0014	WD Angled Abutment 2 °15mm	Ti 6Al 4V ELI
	MWD0015	WD Angled Abutment 3 °15mm	Ti 6Al 4V ELI
	MWD0043	WD Anti-rotation Temporary Abutment	Ti 6Al 4V ELI
	MWD0044	WD Free-rotation Temporary Abutment	Ti 6Al 4V ELI
	MWD0045	WD Anti-Rotation Plastic Cylinder Abutment	POM
	MWD3095	WD Anti-rotation Titanium/Plastic Abutment	Ti 6Al 4V ELI / POM
	MWD3097	WD Free-rotation Titanium/Plastic Abutment	Ti 6Al 4V ELI / POM

Screw Retained - Multi Unit Abutment (MU)

	MWD3731	WD Straight Multi Unit Abutment 1mm	Ti 6Al 4V ELI
	MWD3732	WD Straight Multi Unit Abutment 2mm	Ti 6Al 4V ELI
	MWD3733	WD Straight Multi Unit Abutment 3mm	Ti 6Al 4V ELI
	MWD3729	WD Straight Multi Unit Abutment 4mm	Ti 6Al 4V ELI
	MWD3730	WD Straight Multi Unit Abutment 5mm	Ti 6Al 4V ELI
	MWD3734	WD Angled Multi Unit Abutment 2.5 °17mm	Ti 6Al 4V ELI
	MWD3737	WD Angled Multi Unit Abutment 3.5 °17mm	Ti 6Al 4V ELI
	MWD3735	WD Angled Multi Unit Abutment 3 °30mm	Ti 6Al 4V ELI
	MWD3738	WD Angled Multi Unit Abutment 4 °30mm	Ti 6Al 4V ELI
	TMA-TGH	TMA Healing Cap	Ti 6Al 4V ELI
	TMA-TTC	TMA Titanium Temporary Copying	Ti 6Al 4V ELI
	TMA-PCS	TMA Plastic Casting Sleeve w/Prosthetic Screw	POM
	TMA-A	TMA Abutment Replica	Ti 6Al 4V ELI
	TMA-SRTO	TMA Impression Copying Open Tray	Ti 6Al 4V ELI
	TMA-SRTC	TMA Closed Tray Transfer	Ti 6Al 4V ELI

* The term "impression coping" has been amended to the term "transfer" (the terms are synonymous). Please note that either term may appear in different documentation.

Screw Retaines - Flat Connection

	MWD0030	WD Abutment Flat Connection 2mm	Ti 6Al 4V ELI
	MWD0031	WD Abutment Flat Connection 4mm	Ti 6Al 4V ELI
	FLAT5515	Temporary Cylinder Sleeve Flat Connection	Ti 6Al 4V ELI
	FLAT5737	Implant Replica Flat Connection	Ti 6Al 4V ELI
	FLAT6011	Castable Abutment for Centering Ring Flat Connection	POM
	FLAT6015	Titanium Retaining Screw Flat Connection	Ti 6Al 4V ELI
	FLAT6013	Titanium Gluing Ring Flat Connection	Ti 6Al 4V ELI
	FLAT6017	Long Laboratory Screw Flat Connection	Ti 6Al 4V ELI
	FLAT6018	Centering Ring Flat Connection	Ti 6Al 4V ELI
	FLAT5512	Transfer Flat Connection	Ti 6Al 4V ELI













Ball Attachment - Overdentures Abutment

	MWD0051	WD Ball Attachment 0.5mm	Ti 6Al 4V ELI
	MWD0052	WD Ball Attachment 1mm	Ti 6Al 4V ELI
	MWD0053	WD Ball Attachment 2mm	Ti 6Al 4V ELI
	MWD0054	WD Ball Attachment 3mm	Ti 6Al 4V ELI
	MWD0055	WD Ball Attachment 4mm	Ti 6Al 4V ELI
	MWD0056	WD Ball Attachment 5mm	Ti 6Al 4V ELI
	NC01	Plastic Ball Cap white	Nylon
	NCP	Plastic Ball Cap Pink Soft	Nylon
	HOT	Ball Cap Titanium	Ti 6Al 4V ELI

Analogs

	MWD0007	WD Implant Analog	Ti 6Al 4V ELI
	MIH5740	Ball Attachment Abutment Replica	Stainless Steel

Transfers / Impression Coping

	MWD5109	WD Fix Konisch™ Slim Close Tray Transfer 4mmDx9mmL	Ti 6Al 4V ELI
	MWD5113	WD Fix Konisch™ Slim Close Tray Transfer 4mmDx13mmL	Ti 6Al 4V ELI
	MWD5209	WD Fix Konisch™ Close Tray Transfer 5.2mmDx9mmL	Ti 6Al 4V ELI
	MWD5213	WD Fix Konisch™ Close Tray Transfer 5.2mmDx13mmL	Ti 6Al 4V ELI
	MWD5309	WD Fix Konisch™ Wide Close Tray Transfer 6mmDx9mmL	Ti 6Al 4V ELI
	MWD5313	WD Fix Konisch™ Wide Close Tray Transfer 6mmDx13mmL	Ti 6Al 4V ELI
	MWD5610	WD Fix Konisch™ Slim Open Tray Transfer 4mmDx10mmL	Ti 6Al 4V ELI
	MWD5614	WD Fix Konisch™ Slim Open Tray Transfer 4mmDx14mmL	Ti 6Al 4V ELI
	MWD5510	WD Fix Konisch™ Open Tray Transfer 5.2mmDx10mmL	Ti 6Al 4V ELI
	MWD5514	WD Fix Konisch™ Open Tray Transfer 5.2mmDx14mmL	Ti 6Al 4V ELI
	MWD5410	WD Fix Konisch™ Wide Open Tray Transfer 6mmDx10mmL	Ti 6Al 4V ELI
	MWD5414	WD Fix Konisch™ Wide Open Tray Transfer 6mmDx14mmL	Ti 6Al 4V ELI

* Transfers can be tightened by Star Driver.

* Transfers will be chosen by length and width according to the planned prosthetic treatment and according to the interocclusal distance.

WD Retrieval Screw



MWD3401

WD Retrieval Screw for Abutments

Ti 6Al 4V ELI

WD Screws



MWD0073

WD Conical Implant Cover Screw

Ti 6Al 4V ELI



MWD0001

WD Abutment Screw

Ti 6Al 4V ELI



MWD3406

WD Retaining Screw for MU 1mm

Ti 6Al 4V ELI



MWD3407

WD Retaining Screw for MU 2mm

Ti 6Al 4V ELI



MWD3408

WD Retaining Screw for MU 3mm

Ti 6Al 4V ELI



MWD3409

WD Retaining Screw for MU 4mm

Ti 6Al 4V ELI



MWD3412

WD Retaining Screw for MU 5mm

Ti 6Al 4V ELI



MWD3403

WD Retaining Screw for Angled MU

Ti 6Al 4V ELI



MWD5010

WD Fix Konisch™ Open Tray Transfer Screw Short

Ti 6Al 4V ELI



MWD5014

WD Fix Konisch™ Open Tray Transfer Screw Long

Ti 6Al 4V ELI



MWD5126

WD Fix Konisch™ Close Tray Transfer Screw Short

Ti 6Al 4V ELI







MWD5127

WD Fix Konisch™ Close Tray Transfer Screw Long

Ti 6Al 4V ELI

* All systems are provided with their compatible screws. However, they may also be ordered individually.

Hand Drivers

	MSD0064	Star Hand Driver-Short	Stainless Steel
	MSD0004	Star Hand Driver - Longw	Stainless Steel
	TMA-SHHS	TMA/FC Female Hand Hex Driver - Short	Stainless Steel
	TMA-SHHL	TMA/FC Female Hand Hex Driver - Long	Stainless Steel

Torque Drivers

	MWD0067	WD 2.6mm Torque Driver-Short	Stainless Steel
	MWD0066	WD 2.6mm Torque Driver-Long	Stainless Steel
	MSD0065	Star Torque Driver-Short	Stainless Steel
	MSD0005	Star Torque Driver - Long	Stainless Steel
	TDBA	Torque Driver for Ball Attachment	Stainless Steel
	TMA-SHT	TMA/FC Hex Torque Driver - Short	Stainless Steel
	TMA-SHTL	TMA/FC Hex Torque Driver - Long	Stainless Steel
	WRS	Wrench Ratchet Surgical Instruments Handle	Stainless Steel

Handpiece Drivers and Adaptors

	MWD0068	WD 2.65mm Hex Handpiece Adapter - Short	Stainless Steel
	MWD0071	WD 2.65mm Hex Handpiece Adapter - Medium	Stainless Steel
	MWD0074	WD 2.65mm Hex Handpiece Adapter - Long	Stainless Steel
	MSD0018	Star Handpiece Driver - Short	Stainless Steel
	MSD0019	Star Handpiece Driver - Long	Stainless Steel
	TMA-HAS	TMA/FC Hex Hand Piece Adapter - Short	Stainless Steel
	TMA-HAL	TMA/FC Hex Hand Piece Adapter - Long	Stainless Steel

Fix-1™

One Piece Implant System

The Fix-1™ is a tapered core spiral implant. It is as easy to use as regular crown and bridge dentistry.

Fix-1™ features:

- Minimally invasive surgery in narrow diameter implants
- Immediate function/loading
- Designed for narrow places
- Offers fast and easy flapless procedure
- Fix-1™ implants with narrow diameters are highly suitable replacements for laterals in the maxilla and incisors in the mandible



	L-10mm	L-11.5mm	L-13mm	L-15mm
Ø3.0mm	FO-3010	FO-3011	FO-3013	FO-3015
Ø3.3mm	FO-3310	FO-3311	FO-3313	FO-3315
Ø3.6mm	FO-3610	FO-3611	FO-3613	FO-3615
Ø4.2mm	FO-4210	FO-4211	FO-4213	FO-4215
Ø5.0mm	FO-5010	FO-5011	FO-5013	FO-5015

Packed with:



CA6025

One Piece Driver

Stainless Steel

Fix-1™ Ø 3.0

- ▶ AB/AE Surface
Titanium Alloy - Ti 6Al 4V ELI

Catalog No.	Length mm
FO-3010	10
FO-3011	11.5
FO-3013	13
FO-3015	15

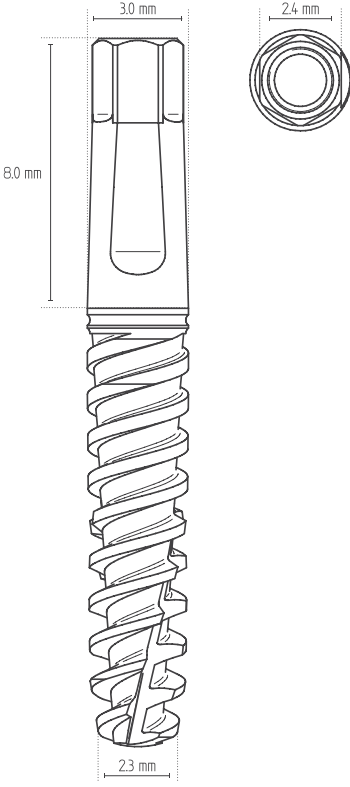
▶ Drill Sequence

BONE TYPE D-IV	BONE TYPE D-II & III	BONE TYPE D-I
1. 2.0	1. 2.0 2. (2.8)	1. 2.0 2. 2.8

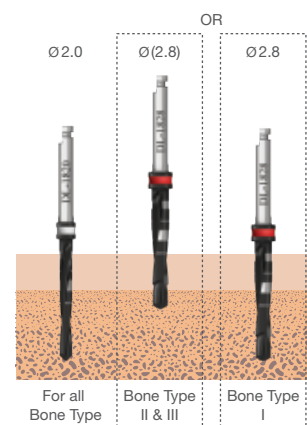

Note: (x.xx) drill to the depth of the cortex only. All measurements are in mm.

⚠ CAUTION: The drill preparation is up to 1mm longer than the implant.

Fix-1™ Ø 3.3

- ▶ AB/AE Surface
Titanium Alloy - Ti 6Al 4V ELI

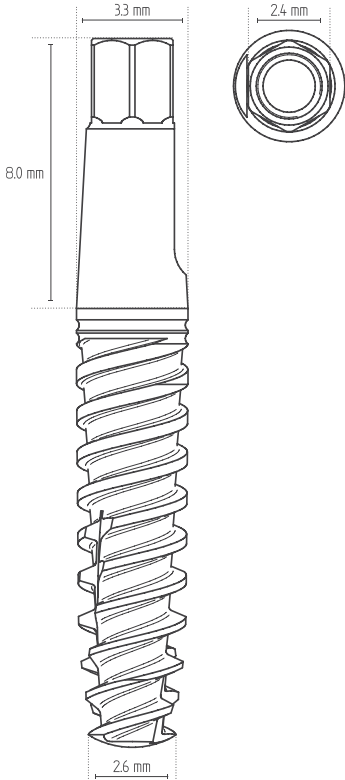
Catalog No.	Length mm		
FO-3310	10		
FO-3311	11.5		
FO-3313	13		
FO-3315	15		

▶ Drill Sequence

BONE TYPE D-IV	BONE TYPE D-II & III	BONE TYPE D-I
1. 2.0	1. 2.0 2. (2.8)	1. 2.0 2. 2.8

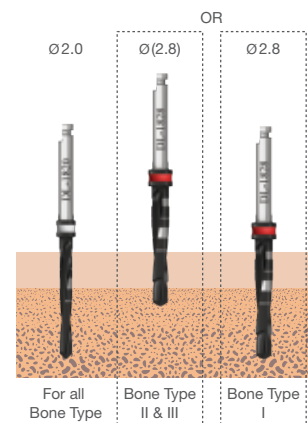

Note: (x.xx) drill to the depth of the cortex only. All measurements are in mm.
 ⚠ CAUTION: The drill preparation is up to 1mm longer than the implant.

Fix-1™ Ø 3.6

- ▶ AB/AE Surface
Titanium Alloy - Ti 6Al 4V ELI

Catalog No.	Length mm
FO-3610	10
FO-3611	11.5
FO-3613	13
FO-3615	15

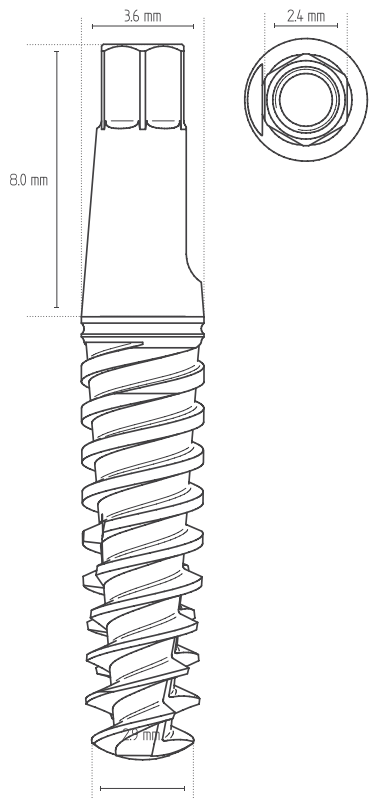
▶ Drill Sequence

BONE TYPE D-IV	BONE TYPE D-II & III	BONE TYPE D-I
1. Tri-Step*	1. Tri-Step* 2. (3.2)	1. Tri-Step* 2. (3.2)

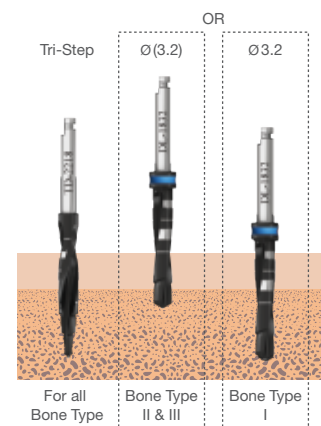

Note: (x.xx) drill to the depth of the cortex only. All measurements are in mm.

- ⚠ CAUTION: The drill preparation is up to 1mm longer than the implant.
- * For initial drilling, you may use 2, 2.8 and 3.2 drills in sequence instead of the Tri-Step drill.

Fix-1™ Ø 4.2

- ▶ AB/AE Surface
Titanium Alloy - Ti 6Al 4V ELI

Catalog No.	Length mm	
FO-4210	10	
FO-4211	11.5	
FO-4213	13	
FO-4215	15	

▶ Drill Sequence

BONE TYPE D-IV	BONE TYPE D-II & III	BONE TYPE D-I
1. Tri-Step* 2. (3.6)	1. Tri-Step* 2. (3.6)	1. Tri-Step* 2. 3.6

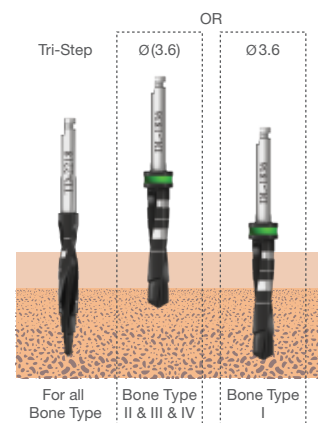

Note: (x.xx) drill to the depth of the cortex only. All measurements are in mm.



CAUTION: The drill preparation is up to 1mm longer than the implant.

* For initial drilling, you may use 2, 2.8 and 3.2 drills in sequence instead of the Tri-Step drill.

Fix-1™ Ø 5.0

- ▶ AB/AE Surface
Titanium Alloy - Ti 6Al 4V ELI

Catalog No.	Length mm	
FO-5010	10	
FO-5011	11.5	
FO-5013	13	
FO-5015	15	

▶ Drill Sequence

BONE TYPE D-IV	BONE TYPE D-II & III	BONE TYPE D-I
1. Tri-Step* 2. 3.6 3. (4.2)	1. Tri-Step* 2. 3.6 3. 4.2 4. (4.6)	1. Tri-Step* 2. 3.6 3. 4.2 4. 4.6

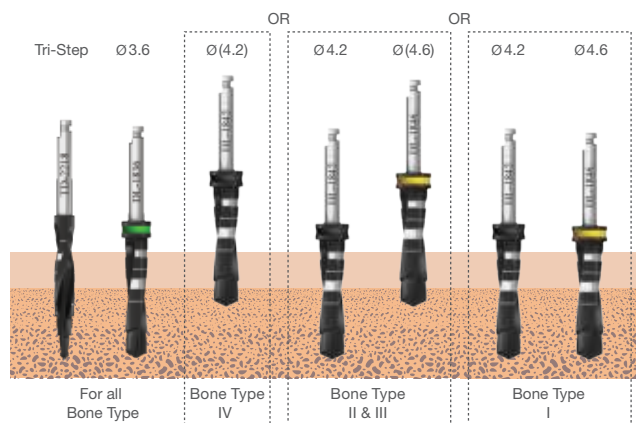

Note: (x.xx) drill to the depth of the cortex only.
All measurements are in mm.

- ⚠ CAUTION: The drill preparation is up to 1mm longer than the implant.
- * For initial drilling, you may use 2, 2.8 and 3.2 drills in sequence instead of the Tri-Step drill.

CAD CAM





CAD CAM IH

Regular Standard
Internal Hex

Ø 3.3 Ø 3.5 Ø 3.75
Ø 4.2 Ø 5 Ø 6

FixTite™ - S | Mars™ | Fix-a-Dent™

Scan body | For Intra-oral and Desktop Scanner

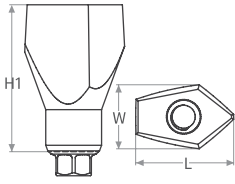

	IH Scan Body 7mm	IH Scan Body 10mm
Catalog No.	MIH0088	MIH0089
Retaining Screw Included	SRAS	MIH3425
Material	TI 6Al 4V ELI	TI 6Al 4V ELI
Dimensions	H1: 7 mm W: 4.3 mm L: 6.7 mm	H1: 10 mm W: 4.4 mm L: 6.8 mm

Ti Bases

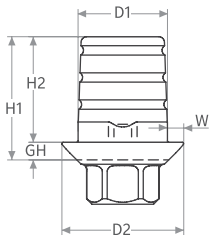

	Anti Rotation	Free Rotation	Angular Anti Rotation
	IH Ti Base Anti-Rotation	IH Ti Base Free-Rotation	IH Ti Base Angular Anti-Rotation
Catalog No.	MIH1404	MIH1408	MIH1417
Retaining Screw Included	SRAS2	SRAS2	SRAS2
Material	TI 6Al 4V ELI	TI 6Al 4V ELI	TI 6Al 4V ELI
Dimensions	H1: 4.6mm H2: 3.9 mm - D1: Ø3.3mm D2: Ø4.5mm W: 0.6mm GH: 0.7mm	H1: 4.6mm H2: 3.9 mm - D1: Ø3.3mm D2: Ø4.5mm W: 0.6mm GH: 0.7mm	H1: 4.6mm H2: 3.9 mm H3: 1.5 mm A: 48° D1: Ø3.3mm D2: Ø4.5 mm W: 0.6mm GH: 0.7mm
Intended Use	Single Unit	Bridge	Single Unit / Angle Correction

Ti Blanks | For Medentika PreFace® Holder

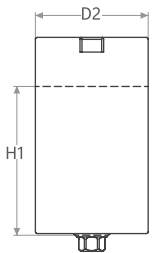

	IH Pre Milled MDTK Ti Blank Ø11.5mm		IH Pre Milled MDTK Ti Blank Ø15.8mm
Catalog No.	MIH1411	Catalog No.	MIH1415
Retaining Screw Included	SRAS2	Retaining Screw Included	SRAS2
Material	TI 6Al 4V ELI	Material	TI 6Al 4V ELI
Dimensions	H1: 15.2mm D2: Ø11.5 mm	Dimensions	H1: 15.2 mm D2: Ø15.8 mm
Intended Use	customized abutment for single unit	Intended Use	customized abutment for single unit



For Screw Retained Restoration

Scan body | For Intra-oral and Desktop Scanner

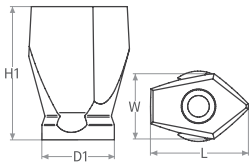

	MU Scan Body 6mm	MU Scan Body 9mm
Catalog No.	MMU0006	MMU0009
Retaining Screw Included	MMU0001	MMU0001
Material	TI 6Al 4V ELI	TI 6Al 4V ELI
Dimensions	H1: 6 mm D1: Ø4.9 mm W: 4.3 mm L: 6.7 mm	H1: 9 mm D1: Ø4.9 mm W: 4.5 mm L: 6.8 mm

Cementing Cone & Cylinder

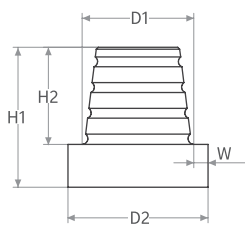

	MU Cementing Cone		Titanium Temporary Copying
Catalog No.	MMU0010	Catalog No.	TMA-TTC
Retaining Screw Included	MMU0001	Retaining Screw Included	TPS
Material	TI 6Al 4V ELI	Material	TI 6Al 4V ELI
Dimensions	H1: 4.9 mm H2: 3.4 mm D1: Ø3.8 mm D2: Ø4.9 mm W: 0.5 mm	Dimensions	H1: 12 mm H2: 10.5 mm D1: Ø3.9 mm D2: Ø4.9 mm W: 0.5 mm



ND Fix Konisch™

Conical-Hex Connection

Ø 3

Narrow Diameter for narrow ridges and tight spaces

Scan body | For Intra-oral and Desktop Scanner

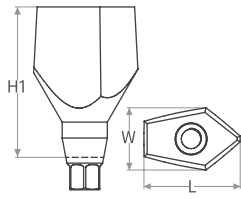

	ND Fix Konisch™ Scan Body 7mm	ND Fix Konisch™ Scan Body 10mm
Catalog No.	MND0088	MND0089
Retaining Screw Included	MND0001	MND0001
Material	TI 6Al 4V ELI	TI 6Al 4V ELI
Dimensions	H1: 7 mm W: 4.2 mm L: 6.7 mm	H1: 10 mm W: 4.5 mm L: 6.9 mm

Ti Bases

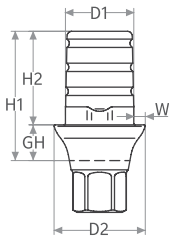

	Anti Rotation	Free Rotation
	ND Fix Konisch™ Ti Base Anti Rotation	ND Fix Konisch™ Ti Base Free Rotation
Catalog No.	MND1004	MND1008
Retaining Screw Included	MND0001	MND0001
Material	TI 6Al 4V ELI	TI 6Al 4V ELI
Dimensions	H1: 5.4 mm H2: 3.9 mm - - D1: Ø 2.9 mm D2: Ø 3.8 mm W: 0.5 mm GH: 1.5 mm	H1: 5.4 mm H2: 3.9 mm - - D1: Ø 2.9 mm D2: Ø 3.8 mm W: 0.5 mm GH: 1.5 mm
Intended Use	Single Unit	Bridge

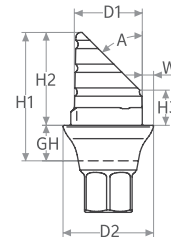

	Angular Anti Rotation
	ND Fix Konisch™ Ti Base Anti Rotation
Catalog No.	MND1017
Retaining Screw Included	MND0001
Material	TI 6Al 4V ELI
Dimensions	H1: 5.4 mm H2: 3.9 mm H3: 1.5 mm A: 45° D1: Ø 2.9 mm D2: Ø 3.8 mm W: 0.5 mm GH: 1.5 mm
Intended Use	Single Unit / Angle Correction

Ti Blanks | For Medentika PreFace® Holder

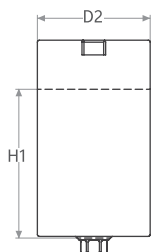

	ND Fix Konisch™ Pre Milled MDTK Ti Blank Ø 11.5mm		ND Fix Konisch™ Pre Milled MDTK Ti Blank Ø 11.5mm
Catalog No.	MND1111	Catalog No.	MND1115
Retaining Screw Included	MND0001	Retaining Screw Included	MND0001
Material	TI 6Al 4V ELI	Material	TI 6Al 4V ELI
Dimensions	H1: 15.4 mm D2: Ø 11.5 mm	Dimensions	H1: 15.4 mm D2: Ø 15.8 mm
Intended Use	customized abutment for single unit	Intended Use	customized abutment for single unit



SD Fix Konisch™

Conical-Hex Connection

Ø 3.5

Standard Diameter for size ridges and spaces

Scan body | For Intra-oral and Desktop Scanner

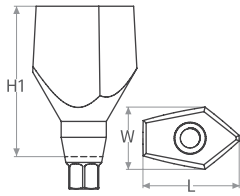

	SD Fix Konisch™ Scan Body 7mm	SD Fix Konisch™ Scan Body 10mm
Catalog No.	MSD0088	MSD0089
Retaining Screw Included	MSD0001	MSD0001
Material	TI 6Al 4V ELI	TI 6Al 4V ELI
Dimensions	H1: 7 mm W: 4.3 mm L: 6.7 mm	H1: 10 mm W: 4.5 mm L: 6.9 mm

Ti Bases

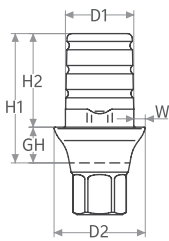

	Anti Rotation	Free Rotation		Angular Anti Rotation
	SD Fix Konisch™ Ti Base Anti Rotation	SD Fix Konisch™ Ti Base Free Rotation		SD Fix Konisch™ Ti Base Anti Rotation
Catalog No.	MSD1204	MND1008	Catalog No.	MSD1217
Retaining Screw Included	MSD0001	MND0001	Retaining Screw Included	MSD0001
Material	TI 6Al 4V ELI	TI 6Al 4V ELI	Material	TI 6Al 4V ELI
Dimensions	H1: 4.9 mm H2: 3.9 mm - - D1: Ø 3.3 mm D2: Ø 4.5 mm W: 0.6 mm GH: 1.0 mm	H1: 5.4 mm H2: 3.9 mm - - D1: Ø 3.3 mm D2: Ø 4.5 mm W: 0.6 mm GH: 1.0 mm	Dimensions	H1: 4.9 mm H2: 3.9 mm H3: 1.5 mm A: 48° D1: Ø 3.3 mm D2: Ø 4.5 mm W: 0.6 mm GH: 1.0 mm
Intended Use	Single Unit	Bridge	Intended Use	Single Unit / Angle Correction

Ti Blanks | For Medentika PreFace® Holder

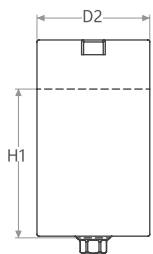

	SD Fix Konisch™ Pre Milled MDTK Ti Blank Ø11.5mm		SD Fix Konisch™ Pre Milled MDTK Ti Blank Ø15.8mm
Catalog No.	MSD1211	Catalog No.	MSD1215
Retaining Screw Included	MSD0001	Retaining Screw Included	MSD0001
Material	TI 6Al 4V ELI	Material	TI 6Al 4V ELI
Dimensions	H1: 15.2 mm D2: Ø 11.5 mm	Dimensions	H1: 15.2 mm D2: Ø 15.8 mm
Intended Use	customized abutment for single unit	Intended Use	customized abutment for single unit



WD Fix Konisch™

Conical-Hex Connection

Ø 4.3 Ø 5

Wide Diameter for wide / large ridges and spaces

Scan body | For Intra-oral and Desktop Scanner

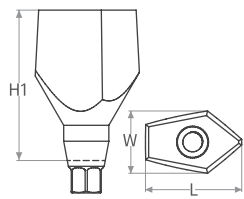

	WD Fix Konisch™ Scan Body 7mm	WD Fix Konisch™ Scan Body 10mm
Catalog No.	MWD0088	MWD0089
Retaining Screw Included	MWD0001	MWD0001
Material	TI 6Al 4V ELI	TI 6Al 4V ELI
Dimensions	H1: 7 mm W: 4.3 mm L: 6.7 mm	H1: 10 mm W: 4.5 mm L: 6.9 mm

Ti Bases

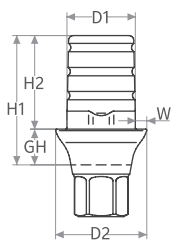

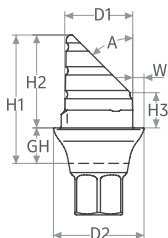
	Anti Rotation	Free Rotation		Angular Anti Rotation
	WD Fix Konisch™ Ti Base Anti Rotation	WD Fix Konisch™ Ti Base Free Rotation		WD Fix Konisch™ Ti Base Angular anti-rotation
Catalog No.	MWD1304	MWD1308	Catalog No.	MWD1317
Retaining Screw Included	MWD0001	MWD0001	Retaining Screw Included	MWD0001
Material	TI 6Al 4V ELI	TI 6Al 4V ELI	Material	TI 6Al 4V ELI
Dimensions	H1: 4.7 mm H2: 3.9 mm - - D1: Ø 3.5 mm D2: Ø 4.5 mm W: 0.5 mm GH: 0.8 mm	H1: 4.7 mm H2: 3.9 mm - - D1: Ø 3.5 mm D2: Ø 4.5 mm W: 0.5 mm GH: 0.8 mm	Dimensions	H1: 4.7 mm H2: 3.9 mm H3: 1.5 mm A: 51.5° D1: Ø 3.5 mm D2: Ø 4.5 mm W: 0.5 mm GH: 0.8 mm
Intended Use	Single Unit	Bridge	Intended Use	Single Unit / Angle Correction

Ti Blanks | For Medentika PreFace® Holder

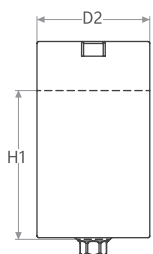

	WD Fix Konisch™ Pre Milled MDTK Ti Blank Ø 11.5mm		WD Fix Konisch™ Pre Milled MDTK Ti Blank Ø 15.8mm
Catalog No.	MSD1211	Catalog No.	MSD1215
Retaining Screw Included	MSD0001	Retaining Screw Included	MSD0001
Material	TI 6Al 4V ELI	Material	TI 6Al 4V ELI
Dimensions	H1: 15.2 mm D2: Ø 11.5 mm	Dimensions	H1: 15.2 mm D2: Ø 15.8 mm
Intended Use	customized abutment for single unit	Intended Use	customized abutment for single unit



Accessories



Screws, Tools, Analogs & Replica

Screws



Fix Konisch™

	ND Abutment Screw	SD Abutment Screw	WD Abutment Screw
			
Catalog No.	MND0001	MSD0001	MWD0001
Material	TI 6Al 4V ELI	TI 6Al 4V ELI	TI 6Al 4V ELI
Intended use	For ND Scan Body, Bases and Ti Blanks	For SD Scan Body, Bases and Ti Blanks	For WD Scan Body, Bases and Ti Blanks

HI Regular Standard Internal Hex



	IH Prosthetic Screw	IH Screw For Closed Tray Transfer	IH Short Prosthetic Screw
			
Catalog No.	SRAS	MIH3425	SRAS2
Material	TI 6Al 4V ELI	TI 6Al 4V ELI	TI 6Al 4V ELI
Intended Use	For IH Scan Body 7mm	For IH Scan Body 10mm	For IH Ti Bases and Ti Blanks

MU - Multi Ubit



	MU Scan Body Screw	MU Prosthetic Screw
		
Catalog No.	MMU0001	TPS
Material	TI 6Al 4V ELI	TI 6Al 4V ELI
Intended Use	For MU Scan Body and Cementing Cone	For MU Cylinder and MU direct option

Analogs & Replica*



Digital analog for Fix Konisch™

	ND Digital Model Analog	SD Digital Model Analog	WD Digital Model Analog
			
Catalog No.	MND1000	MSD1000	MWD1000
Material	TI 6Al 4V ELI	TI 6Al 4V ELI	TI 6Al 4V ELI

Digital Analog for IH and MU

	IH Digital Model Analog	MU Digital Model abutment Replica
		
Catalog No.	MIH1000	MIH1001
Material	TI 6Al 4V ELI	TI 6Al 4V ELI

Tools

	Star Hand driver- Short	1.27 Hex Hand Driver- Short
		
Catalog No.	MSD0064	SHHS
	Star Hand driver- Long	1.27 Hex Hand Driver- Medium
Catalog No.	MSD0004	SHHM
Intended Use	Compatible with MU and Fix Konisch™ Platforms: ND, SD, WD	Compatible with IH System: FixTite™-S, Mars™, Fix-a-Dent™

*You may also use any of the following:

SHHL	MSD0065
SHT	MSD0005
SHTL	MSD0018
MIH9030	MSD0019
MIH9035	FIA

Kit & Tools

Standard Internal Hex Surgical Kit
Premium



SURPP: Standard Internal Hex Plastic Surgical Kit - Premium**DRILLS:**

MTD1	Tip Drill
2218TDM	Three Step Drill - Long
1820DM	Pilot Drill 2mmD x 8-18mmL
1828DM	Twist Step Drill 2.3/2.8mmD x 8-18mmL
1832DM	Twist Step Drill 2.8/3.2mmD x 8-18mmL
1836DM	Twist Step Drill 3.2/3.6mmD x 8-18mmL
1842DM	Twist Step Drill 3.8/4.2mmD x 8-18mmL
1846DM	Twist Step Drill 4.2/4.6mmD x 8-18mmL
1852DM	Twist Step Drill 4.8/5.2mmD x 8-18mmL
1511TDM	Three Step Drill - Short
1320DM	Pilot Drill 2mmD x 6-13mmL
1328DM	Twist Step Drill 2.3/2.8mmDx6-13mmL
1332DM	Twist Step Drill 2.8/3.2mmDx6-13mmL
1336DM	Twist Step Drill 3.2/3.6mmDx6-13mmL
1342DM	Twist Step Drill 3.8/4.2mmDx6-13mmL
1346DM	Twist Step Drill 4.2/4.6mmDx6-13mmL
1352DM	Twist Step Drill 4.8/5.2mmDx6-13mmL
1356DM	Twist Step Drill 5.2/5.6mmDx6-13mmL

PARALLEL PINS:

PAPS	Parallel Pin 11 (qty. 4)
PAPL	Parallel Pin 16 (qty. 2)

TOOLS:

SHHA9021	Hex Handpiece Adapter - Short
MHHA9026	Hex Handpiece Adapter - Medium
LHHA9026	Hex Handpiece Adapter - Long

HEX HAND DRIVERS:

SHHS	1.27 Hex Hand Driver - Short
SHHM	1.27 Hex Hand Driver - Medium

HEX TORQUE DRIVERS:

SHT	1.27 Hex Torque Driver - Short
SHTL	1.27 Hex Torque Driver - Long

DRILL EXTENSION:

ITHS	Drill Extension
SRS	Surgical Torque Ratchet 35-100 Ncm
WRS	Wrench Ratchet Surgical Instruments Handle
DP6180	Depth Probe

SURPA: Standard Internal Hex Plastic Surgical Kit - Advanced**DRILLS:**

1820DM	Pilot Drill 2mmD x 8-18mmL
1828DM	Twist Step Drill 2.3/2.8mmD x 8-18mmL
1832DM	Twist Step Drill 2.8/3.2mmD x 8-18mmL
1836DM	Twist Step Drill 3.2/3.6mmD x 8-18mmL
1842DM	Twist Step Drill 3.8/4.2mmD x 8-18mmL
1846DM	Twist Step Drill 4.2/4.6mmD x 8-18mmL

PARALLEL PINS:

PAPS	Parallel Pin 11 (qty. 4)
PAPL	Parallel Pin 16 (qty. 2)
WRS	Wrench Ratchet Surgical Instruments Handle

TOOLS:

SHHA9021	RS Hex Handpiece Adapter Short
MHHA9026	RS Hex Handpiece Adapter Medium
LHHA9029	RS Hex Hand Piece Adapter Long

HEX HAND DRIVERS:

SHHS	1.27 Hex Hand Driver - Short
SHHM	1.27 Hex Hand Driver - Medium

HEX TORQUE DRIVERS::

SHT	1.27 Hex Torque Driver - Short
SHTL	1.27 Hex Torque Driver - Long

DRILL EXTENSION:

ITHS	Drill Extension
SRS	Surgical Torque Ratchet 35-100 Ncm
DP6180	Depth Probe

Also available with short drills

SURPAS Standard Internal Hex Plastic Surgical Kit - Advanced Short Drills

SURPS: Standard Internal Hex Plastic Surgical Kit - starter**DRILLS:**

1820DM	Pilot Drill 2mmD x 8-18mmL
1828DM	Twist Step Drill 2.3/2.8mmD x 8-18mmL
1832DM	Twist Step Drill 2.8/3.2mmD x 8-18mmL
1836DM	Twist Step Drill 3.2/3.6mmD x 8-18mmL
1842DM	Twist Step Drill 3.8/4.2mmD x 8-18mmL
1846DM	Twist Step Drill 4.2/4.6mmD x 8-18mmL

TOOLS:

SHHA9021	RS Hex Handpiece Adapter Short
MHHA902	RS Hex Handpiece Adapter Medium
LHHA9029	RS Hex Hand Piece Adapter Long

HEX HAND DRIVERS:

SHHS	1.27 Hex Hand Driver - Short
SHHM	1.27 Hex Hand Driver - Medium

SR	Wrench Ratchet
WRS	Wrench Ratchet Surgical Instruments Handle

Also available with short drills

SURPSS Standard Internal Hex Plastic Surgical Kit - Starter Short Drills

Fix Konisch™ Surgical Kit
Premium



FK6300: Fix Konisch™ Surgical Kit - Premium

SRS	Surgical Torque Ratchet 35-100 Ncm	1342DM	Twist Step Drill 3.8/4.2mmD x 6-13mmL
DP6180	Depth Probe	1346DM	Twist Step Drill 4.2/4.6mmD x 6-13mmL
PAPS	Parallel Pin 11	ITHS	Drill Extension
PAPL	Parallel Pin 16	MSD0064	Star Hand Driver-Short
MTD1	Tip Drill	MSD0004	Star Hand Driver - Long
1511TDM	Three Step Drill-Short	MSD0065	Star Torque Driver - Short
2218TDM	Three Step Drill-Long	MSD0005	Star Torque Driver - Long
1820DM	Pilot Drill 2mmD x 8-18mmL	MND0068	ND 2mm Hex Handpiece Adapter - Short
1828DM	Twist Step Drill 2.3/2.8mmD x 8-18mmL	MND0071	ND 2mm Hex Handpiece Adapter - Medium
1832DM	Twist Step Drill 2.8/3.2mmD x 8-18mmL	MND0074	ND 2mm Hex Handpiece Adapter - Long
1836DM	Twist Step Drill 3.2/3.6mmD x 8-18mmL	MSD0068	SD 2.25mm Hex Handpiece Adapter - Short
1842DM	Twist Step Drill 3.8/4.2mmD x 8-18mmL	MSD0071	SD 2.25mm Hex Handpiece Adapter - Medium
1846DM	Twist Step Drill 4.2/4.6mmD x 8-18mmL	MSD0074	SD 2.25mm Hex Handpiece Adapter - Long
1320DM	Pilot Drill 2mmD x 6-13mmL	MWD0068	WD 2.65mm Hex Handpiece Adapter - Short
1328DM	Twist Step Drill 2.3/2.8mmD x 6-13mmL	MWD0071	WD 2.65mm Hex Handpiece Adapter - Medium
1332DM	Twist Step Drill 2.8/3.2mmD x 6-13mmL	MWD0074	WD 2.65mm Hex Handpiece Adapter - Long
1336DM	Twist Step Drill 3.2/3.6mmD x 6-13mmL	WRS	Wrench Ratchet Surgical Instruments Handl

FK6302: Fix Konisch™ Surgical Kit - Advanced

SRS	Surgical Torque Ratchet 35-100 Ncm	MSD0004	Star Hand Driver - Long
DP6180	Depth Probe	MSD0065	Star Torque Driver - Short
PAPS	Parallel Pin 11	MSD0005	Star Torque Driver - Long
PAPL	Parallel Pin 16	MND0068	ND 2mm Hex Handpiece Adapter - Short
1820DM	Pilot Drill 2mmD x 8-18mmL	MND0071	ND 2mm Hex Handpiece Adapter - Medium
1828DM	Twist Step Drill 2.3/2.8mmD x 8-18mmL	MND0074	ND 2mm Hex Handpiece Adapter - Long
1832DM	Twist Step Drill 2.8/3.2mmD x 8-18mmL	MSD0068	SD 2.25mm Hex Handpiece Adapter - Short
1836DM	Twist Step Drill 3.2/3.6mmD x 8-18mmL	MSD0071	SD 2.25mm Hex Handpiece Adapter - Medium
1842DM	Twist Step Drill 3.8/4.2mmD x 8-18mmL	MSD0074	SD 2.25mm Hex Handpiece Adapter - Long
1846DM	Twist Step Drill 4.2/4.6mmD x 8-18mmL	MWD0068	WD 2.65mm Hex Handpiece Adapter - Short
ITHS	Drill Extension	MWD0071	WD 2.65mm Hex Handpiece Adapter - Medium
MSD0064	Star Hand Driver-Short	MWD0074	WD 2.65mm Hex Handpiece Adapter - Long
		WRS	Depth Wrench Ratchet Surgical Instruments Handle

Tools

Tools

SRS



Surgical Torque Ratchet 35-100 Ncm

Stainless Steel

PTR



Prosthetic Torque Ratchet 15-35 Ncm

Stainless Steel

SR



Wrench Ratchet

Stainless Steel

SDH1



Surgical Driver

Stainless Steel

DP6180



Depth Probe

Stainless Steel

PAPS



Parallel Pin 11
Stainless Steel

PAPL



Parallel Pin 16
Stainless Steel

Osteotomes

SOS-H



Osteotome Handle

Aluminium + Stainless Steel

SOS20



Straight Convex Osteotome 2.0mmD

Ti 6Al 4V ELI

SOS325



Straight Convex Osteotome 3.25mmD

Ti 6Al 4V ELI

SOS28



Straight Convex Osteotome 2.8mmD

Ti 6Al 4V ELI

SOS365



Straight Convex Osteotome 3.65mmD

Ti 6Al 4V ELI

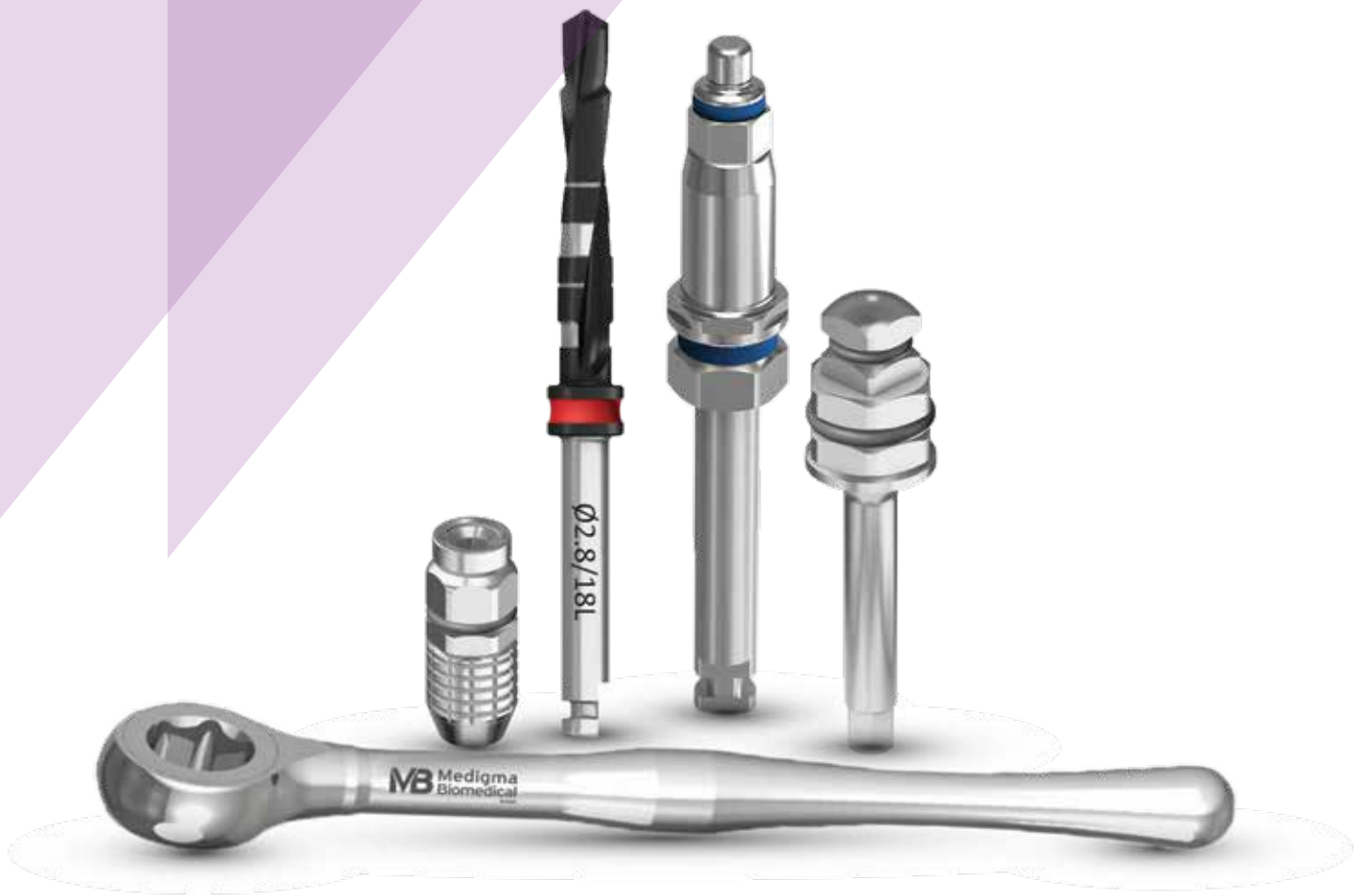

Standard Internal Hex Surgical Tools



SMTS

2.4 Hex Torque Driver - Short

Stainless



SMTL

2.4 Hex Torque Driver - Long

Stainless

Standard Internal Hex Prosthetic Tools



SHT

1.27 Hex Torque Driver - Short

Stainless Steel



SHTL

1.27 Hex Torque Driver - Long

Stainless Steel



SHHM

1.27 Hex Hand Driver - Medium

Stainless Steel



SHHS

1.27 Hex Hand Driver - Short

Stainless Steel



SHHL

1.27 Hex Hand Driver - Long

Stainless Steel



TDBA

Torque Driver for Ball Attachment

Stainless Steel



TMA-HAS

TMA / FC Hex Handpiece Adapter - Short

Stainless Steel



TMA-HAL

TMA / FC Hex Handpiece Adapter - Long

Stainless Steel



TMA-SHT

TMA / FC Hex Torque Driver - Short

Stainless Steel



TMA-SHTL

TMA / FC Hex Torque Driver - Long

Stainless Steel



TMA-SHHS

TMA / FC Female Hand Hex Driver - Short

Stainless Steel























TMA-SHHL

TMA / FC Female Hand Hex Driver - Long

Stainless Steel

Surgical Drills

Two Step DLC Drills - Long				
	1820DM	Pilot Drill 2mmD x 8-18mmL White	White	Stainless Steel & DLC
	1828DM	Twist Step Drill 2.3/2.8mmD x 8-18mmL	Red	Stainless Steel & DLC
	1832DM	Twist Step Drill 2.8/3.2mmD x 8-18mmL	Blue	Stainless Steel & DLC
	1836DM	Twist Step Drill 3.2/3.6mmD x 8-18mmL	Green	Stainless Steel & DLC
	1842DM	Twist Step Drill 3.8/4.2mmD x 8-18mmL	Black	Stainless Steel & DLC
	1846DM	Twist Step Drill 4.2/4.6mmD x 8-18mmL	Yellow	Stainless Steel & DLC
	1852DM	Twist Step Drill 4.8/5.2mmD x 8-18mmL	Brown	Stainless Steel & DLC
	1856DM	Twist Step Drill 5.2/5.6mmD x 8-18mmL	Grey	Stainless Steel & DLC
Two Step DLC Drills - Short				
	1320DM	Pilot Drill 2mmD x 6-13mmL	White	Stainless Steel & DLC
	1328DM	Twist Step Drill 2.3/2.8mmD x 6-13mmL	Red	Stainless Steel & DLC
	1332DM	Twist Step Drill 2.8/3.2mmD x 6-13mmL	Blue	Stainless Steel & DLC
	1336DM	Twist Step Drill 3.2/3.6mmD x 6-13mmL	Green	Stainless Steel & DLC
	1342DM	Twist Step Drill 3.8/4.2mmD x 6-13mmL	Black	Stainless Steel & DLC
	1346DM	Twist Step Drill 4.2/4.6mmD x 6-13mmL	Yellow	Stainless Steel & DLC
	1352DM	Twist Step Drill 4.8/5.2mmD x 6-13mmL	Brown	Stainless Steel & DLC
	1356DM	Twist Step Drill 5.2/5.6mmD x 6-13mmL	Grey	Stainless Steel & DLC
Three Step DLC Drills				
	1511TDM	Three Step Drill-Short		Stainless Steel & DLC
	2218TDM	Three Step Drill-Long		Stainless Steel & DLC
Tip Drill				
	MTD1	Tip Drill		Stainless Steel
Drill Extension				
	ITHS	Drill Extension		Stainless Steel

Drill Stoppers

Long Drill - Regular



Each Drill Stop is marked with width and length.
 Note: Some stops are suitable for long and short drill according to the following markings.
 L: Drill length for long drill (18 mm)
 S: Drill length for short drill (13 mm)

Short Drill 13mm

L	2.0mmD	2.8mmD	3.2mmD	3.6mmD	4.2mmD	4.6mmD	5.2mmD	5.6mmD
6mm	1320L6SM	1328L6SM	1332L6SM	1336L6SM	1342L6SM	1346L6SM	1352L6SM	1356L6SM
8mm	1820L13SM	1828L13SM	1832L13SM	1836L13SM	1842L13SM	1846L13SM	1852L13SM	1856L13SM
10mm	1820L15SM	1828L15SM	1832L15SM	1836L15SM	1842L15SM	1846L15SM	1852L15SM	1856L15SM
11.5mm	1320L11SM	1328L11SM	1332L11SM	1336L11SM	1342L11SM	1346L11SM	1352L11SM	1356L11SM

Long Drill 18mm

L	2.0mmD	2.8mmD	3.2mmD	3.6mmD	4.2mmD	4.6mmD	5.2mmD	5.6mmD
6mm	1820L6SM	1828L6SM	1832L6SM	1836L6SM	1842L6SM	1846L6SM	1852L6SM	1856L6SM
8mm	1820L8SM	1828L8SM	1832L8SM	1836L8SM	1842L8SM	1846L8SM	1852L8SM	1856L8SM
10mm	1820L10SM	1828L10SM	1832L10SM	1836L10SM	1842L10SM	1846L10SM	1852L10SM	1856L10SM
11.5mm	1820L11SM	1828L11SM	1832L11SM	1836L11SM	1842L11SM	1846L11SM	1852L11SM	1856L11SM
13mm	1820L13SM	1828L13SM	1832L13SM	1836L13SM	1842L13SM	1846L13SM	1852L13SM	1856L13SM
15mm	1820L15SM	1828L15SM	1832L15SM	1836L15SM	1842L15SM	1846L15SM	1852L15SM	1856L15SM
16mm	1820L16SM	1828L16SM	1832L16SM	1836L16SM	1842L16SM	1846L16SM	1852L16SM	1856L16SM

Drill Stop Kits	
S1001M	Long Drill Stop Kit - Regular
S1002M	Long Drill Stop Kit - Wide
S1003M	Short Drill Stop Kit - Regular
S1004M	Short Drill Stop Kit - Wide





www.medigma-implants.com

 +49 175 8726995

 Siemensstrasse D-78564 Wehingen, Germany

 office@medigma-implants.com